



DEEP SEA ELECTRONICS

560

Auto Start Instrumentation Module

UL RECOGNISED COMPONENT

Issue 1
VH 7/1/02

FEATURES

- ▶ **Micro-processor based design**
- ▶ **Automatic engine starting and stopping**
- ▶ **Automatic shutdown on fault condition**
- ▶ **Custom graphical icon LCD display**
- ▶ **PC configurable via MS-Windows™ based software**
- ▶ **Provides engine instrumentation**
- ▶ **Provides generator output instrumentation**
- ▶ **Provides alarm and status Information**
- ▶ **Simple selector switch controlled operation**
- ▶ **Real time diagnostics via MS-Windows™**
- ▶ **Configurable digital inputs**
- ▶ **Configurable relay outputs**
- ▶ **Configurable timer settings**
- ▶ **Configurable alarm trip points**
- ▶ **Expansion modules for further enhancement**
- ▶ **External remote start input**
- ▶ **LED & LCD alarm indication**
- ▶ **Adjustable crank cycle/attempts**

DESCRIPTION

The Model 560 is an **Automatic Engine Control Module recognised to UL 508**. The module is used to automatically start and stop the engine and indicate operational status and fault conditions. It will automatically shut down the engine and indicate the engine failure by means of a graphical LCD display and a flashing LED on the front panel.

Operation of the module is via a three-position, rotary switch (key-switch option available) mounted on the front panel with STOP, AUTO and MANUAL positions.

The module features microprocessor control and provides a comprehensive list of timers and pre-configured sequences. This allows complex specifications to be realised.

Selected operational sequences, timers and alarms can be altered by the customer. Configuration changes to the system are made by using the 808 interface and a PC. This interface also provides real time diagnostic facilities.

Configurable expansion facilities are also provided.

The 560 also provides **metering and alarm facilities** via the LCD display which is accessed via the 'display scroll' push-button. The following instrumentation displays are available:

- ▶ Generator Volts L1-N, L2-N, L3-N
- ▶ Generator Volts L1-L2, L2-L3, L3-L1
- ▶ Generator Amps L1,L2,L3
- ▶ Generator Frequency Hz
- ▶ Engine Speed RPM
- ▶ Engine Oil Pressure (PSI, Bar & kPa)
- ▶ Engine Temperature (°C & °F)
- ▶ Plant battery Volts
- ▶ Engine Hours Run

e.g.

L1-L2	L2-L3	L3-L1
420	391	~ V
405		



The module accepts the following **digital inputs**:

- ▶ Emergency Stop Input - N/C DC positive input
- ▶ 5 Fully configurable warning or shutdown inputs

With the exception of the Emergency Stop Input, these are configurable to be either N/C or N/O contacts, switched to the negative DC. The five fully configurable auxiliary inputs can be selected to be indication, warning or shutdown inputs either immediate or held off during start-up, to allow for use as protection expansion inputs. Alternatively they may be configured to control extra functions such as Lamp Test, Remote Start input and many others.

Engine **analogue inputs** are provided for Oil Pressure and Engine Temperature. These connect to conventional engine mounted resistive sender units (such as VDO or Datcom type) to provide accurate monitoring and protection facilities. Alternatively they can be configured to interface with digital switch type inputs for Low Oil Pressure and High Engine Temperature shutdowns.

Description continues overleaf...

DESCRIPTION CONTINUED

Relay outputs are provided for Fuel Solenoid, Start Solenoid and three configurable outputs. The configurable relay functions can be selected from a range of different functions, conditions or alarms. The relays supply positive plant supply out. Additional output relays can be added by means of the 157 Relay Expansion Module. A total of 11 outputs are available with full expansion of the 560 Module. This allows the module system to be incorporated into existing telemetry or building management schemes via volt-free contacts.

Multiple alarm channels are provided to monitor the following:

- ▶ Under/Over Generator Volts
- ▶ Under/Over Generator Frequency
- ▶ Under/Overspeed
- ▶ Charge Fail
- ▶ Emergency Stop
- ▶ Low Oil Pressure Warning/shutdown
- ▶ High Engine Temperature Warning/shutdown
- ▶ Fail to Start (over crank)
- ▶ Low/High DC Battery Volts
- ▶ Fail to come to rest
- ▶ Loss of Speed Sensing Signal
- ▶ Generator High Current Warning

along with any configurable input alarms as selected.

The instrumentation displays are provided by **LCD icon displays for the various alarms**

e.g.

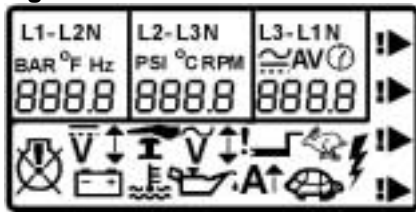

2-colour LED indication is also provided for alarm present:

Amber steady = *Warning*
Red flashing = *Shutdown*

Uncommitted LCD icons allow the user to configure the module to provide other status or alarm indications from either internal states or from external digital inputs.

The 500 series modules have been designed for **front panel mounting**. The module is fitted into the cut-out with the fixing clips removed. These are then fitted from the rear.

Connection is via locking plug and socket connectors.

SPECIFICATION

DC Supply:

8 to 35 V Continuous.

Cranking Dropouts:

Able to survive 0 V for 50 mS, providing supply was at least 10 V before dropout and supply recovers to 5V. *This is achieved without the need for internal batteries.*

Max. Operating Current:

390mA at 12 V. 250mA at 24 V.

Max. Standby Current:

220mA at 12 V. 120mA at 24 V.

Alternator Input Range:

300 VAC (max) 3 phase 4 wire, single phase 2 wire, or 3 phase 3 wire (option)

Alternator Input Frequency:

50 - 60 Hz at rated engine speed (Minimum: 15V AC Ph-N)

Magnetic Pick-up Voltage Input Range:

+/- 0.5 V to 70 V Peak

Magnetic Input Frequency:

10,000 Hz

(max) at rated engine speed.

Start Relay Output:

10 Amp DC at supply voltage.

Fuel Relay Output:

10 Amp DC at supply voltage.

Auxiliary Relay Outputs:

2 Amp DC at supply voltage.

Dimensions:

7.56 x 5.67 x 5.43 ins

192 x 144 x 138mm

Charge Fail / Excitation Range:

0 V to 35 V

Operating Temperature Range:

To +40°C typical (104°F)

Environment

Pollution Degree 2

Overvoltage Category III

▶ **Compliant with BS EN 60950 Low Voltage Directive**

























▶ **Compliant with BS EN 50081-2 EMC Directive**

▶ **Compliant with BS EN 50082-2 EMC Directive**

TIMERS AND FUNCTIONS

- ▶ **Start Delay timer**
- ▶ **Stop Delay timer**
- ▶ **Crank/Crank Rest timers**
- ▶ **Safety On Delay timer**
- ▶ **Warm-up timer**
- ▶ **Cooling timer**
- ▶ **Energise to Stop hold timer**
- ▶ **Pre-heat timer**
- ▶ **Smoke Limiting control timers**
- ▶ **Fail to Stop timer**
- ▶ **Over-speed Overshoot timer**
- ▶ **DC Battery Alarm Delay timers**
- ▶ **LCD Back-lighting for low light level operation**
- ▶ **Alternator Under/Over Volts Shutdown**
- ▶ **Alternator Under/Over Freq. Shutdown**
- ▶ **Under/Over Speed Shutdown**
- ▶ **Low Oil Pressure Shutdown**
- ▶ **High Engine Temp Shutdown**
- ▶ **Low/High Battery Volts Warning**
- ▶ **Generator High Current Warning**
- ▶ **Pin compatible with 55x module**

GRAPHICAL LCD DISPLAY

Display Symbol	Description	Display Symbol	Description
	Shutdown Alarm	L1- L2	Line - Line
	Warning Alarm	L2- L3	Line - Line
	High Coolant Temperature	L3- L1	Line - Line
	Low Oil Pressure	L1- N	Line - Neutral
	Charge Fail	L2- N	Line - Neutral
	Over-speed	L3- N	Line -Neutral
	Under-speed	BAR	Pressure
	Fail to start (Over-crank)	Hz	Frequency
	Emergency Stop	°F	Temperature
	Electrical Trip	PSI	Pressure
	Generator High Current	°C	Temperature
	Over Voltage (AC)	RPM	Speed
	Under Voltage (AC)	L1	Line
	Over Voltage (DC)	L2	Line
	Under Voltage (DC)	L3	Line
	Auxiliary Indication	V	Voltage
	Auxiliary Alarm (Warning or Shutdown)	A	Amperes
	AC		Hours Run
	DC		Common Alarm
	Stop/Reset		Auto
	Manual	I	Start (if fitted)
HPA	KPa Oil Pressure Units		

CASE DIMENSIONS

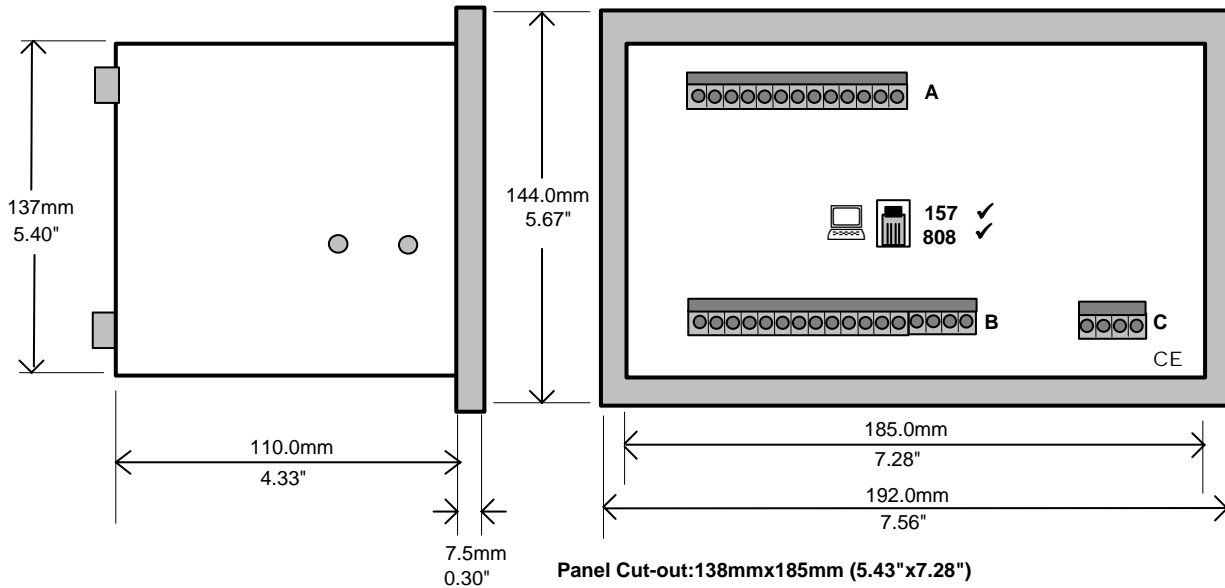

Wire sizes: Connectors A & B – suitable for 12 AWG
 Connector C (generator output) – 14 AWG
Terminal tightening torque: 0.44lbs ft (0.6 N-m)

TYPICAL CONNECTIONS

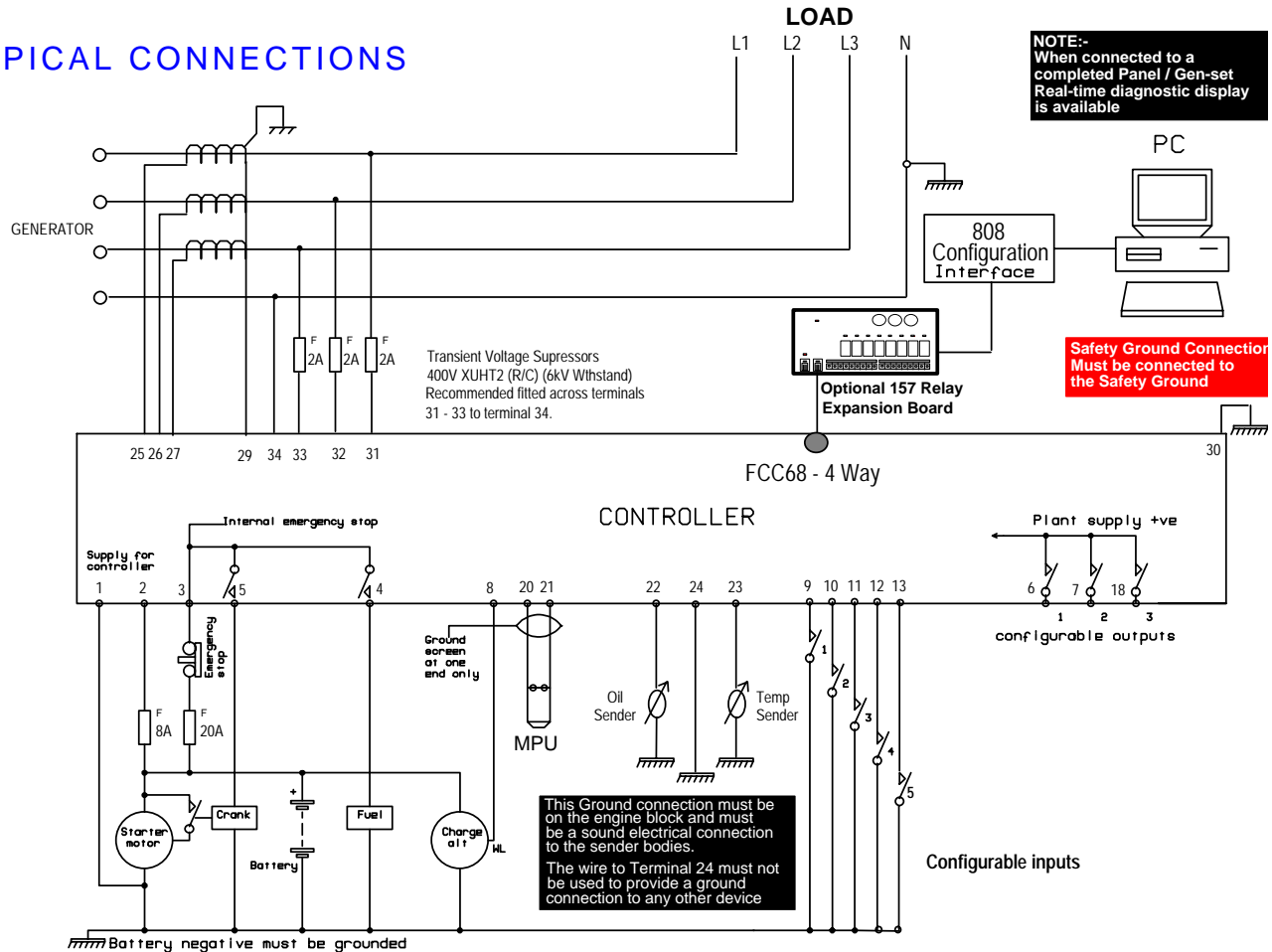

Deep Sea Electronics, Inc.
 3501 East State Street, Suite 202,
 Rockford, IL 61108, USA
 Tel: (815) 316-8706 Fax: (815) 316-8708
 E-mail paul@deepseaUSA.com

Deep Sea Electronics plc
 Highfield House, Hunmanby Industrial Estate,
 North Yorkshire, YO14 0PH, England
 Tel: +44 (0) 1723 890099 Fax: +44 (0) 1723 893303
 E-mail sales@deepseapl.com