

# Deep Sea Electronics Plc

**MODEL 530**

**AUTOMATIC TRANSFER SWITCH**

**CONTROL MODULE**

**Author:- Miles Revell**

**Deep Sea Electronics Plc  
Mountside Park  
Queen Margarets Road  
Scarborough  
North Yorkshire  
YO11 2RH  
England  
Tel: +44 (0) 1723 377566  
Fax: +44 (0) 1723 354453  
E-Mail: Sales@Deepseapl.com**

# TABLE OF CONTENTS

<b>Section</b>	<b>Page</b>
INTRODUCTION.....	3
CLARIFICATION OF NOTATION USED WITHIN THIS PUBLICATION.....	3
1. OPERATION.....	4
1.1 CONTROL.....	4
FIG 1 - FRONT PANEL LAYOUT.....	4
1.2 AUTOMATIC MODE OF OPERATION.....	4
1.3 MANUAL RESTORE MODE OF OPERATION.....	5
1.4 MANUAL OPERATION.....	6
1.5 MANUAL OPERATION WITH EXTERNAL PUSHBUTTONS.....	7
2. FUNCTIONS & INDICATIONS.....	8
FIG 2 - LED DESCRIPTIONS.....	8
2.1 INPUT FUNCTIONS.....	8
2.2 OUTPUT FUNCTIONS.....	10
2.3 AC ONLY OPERATION FUNCTION.....	11
3. INSTALLATION INSTRUCTIONS.....	13
3.1 PANEL CUT-OUT.....	13
FIG 3 - CUT-OUT DIMENSIONS.....	13
3.2 COOLING.....	13
3.3 UNIT DIMENSIONS.....	13
FIG 4 - DIMENSIONS.....	13
3.4 FRONT PANEL LAYOUT.....	14
FIG 5 - FRONT PANEL.....	14
3.5 REAR PANEL LAYOUT.....	14
FIG 6 - REAR PANEL.....	14
4. ELECTRICAL CONNECTIONS.....	15
4.1 CONNECTION DETAILS.....	15
PLUG "A" 20WAY.....	15
PLUG "B" 12 WAY.....	16
4.2 CONNECTOR FUNCTION DETAILS.....	16
PLUG "A" 20 WAY.....	16
PLUG "B" 12 WAY.....	17
CALIBRATION SOCKET.....	17
5. SPECIFICATION.....	18
6. COMMISSIONING.....	19
PRE-COMMISSIONING.....	19
7. FAULT FINDING.....	20
8. TYPICAL WIRING DIAGRAM.....	21
9. CALIBRATION.....	22
9.1 PC INTERFACE MODULE 808.....	22
10. ICON DESCRIPTIONS.....	22
10.1 ICONS.....	22
11. APPENDIX.....	23
11.1 LED IDENTIFICATION DIAGRAM.....	23
FIG 7 - AUXILIARY LED'S.....	23
11.2 FACTORY DEFAULT CONFIGURATION.....	23

# INTRODUCTION

The **530** is a fully configurable automatic transfer switch control module. It is designed to monitor the incoming AC mains supply (1 or 3 phases) for under/over voltage and under/over frequency. Should these fall out of limits the module will issue a start command to the generating set controller. Once the set is available and producing an output within limits the ATS module will control the transfer devices and switch the load from the mains to the generating set. Should the mains supply return to within limits the module will command a return to the mains supply and shut down the generator after a suitable cooling run. Various timing sequences are used to prevent nuisance starting and supply breaks.

Configuration is by PC based software and the proven **808** interface using an FCC68 socket on the rear of the module. This allows rapid and secure configuration of the module and also allows the **157** relay expansion module to be utilised. The FCC68 socket also provides full real-time diagnostics on the status of the **530** module, its inputs and outputs.

Configuration and connection options allow for a wide range of higher functions such as 'Auto start inhibit', 'Manual restore to mains', 'Load inhibit' (both mains and gen-set), 'Lamp test', Push-button transfer control, External mains or Gen-set failure inputs, etc.

A clear mimic diagram with 'International' symbols and LED indications provide at a glance information as to supply availability and load switching status. Further LED indication is provided for 'Start delay in progress' and 'Mains return timer active'. Two user configurable LED's are provided to allow the user to display specific states.

Five user configurable relays are provided to allow control of contactors, different breaker types and engine control modules and alarm systems.

The module features a self seeking power supply which will utilise power from the Mains AC supply or the Generator AC supply. A DC supply to the module is not essential for basic operation, though some higher functions require it.

The module is mounted in a robust plastic case, connection to the module is via plug and socket connectors.

## CLARIFICATION OF NOTATION USED WITHIN THIS PUBLICATION.



**NOTE:**

Highlights an essential element of a procedure to ensure correctness.



**CAUTION!:**

Indicates a procedure or practice which, if not strictly observed, could result in damage or destruction of equipment.



**WARNING!:**

Indicates a procedure or practice which could result in injury to personnel or loss of life if not followed correctly.



DEEP SEA ELECTRONICS PLC own the copyright to this manual, which cannot be copied, reproduced or disclosed to a third party without prior written permission.

# 1. OPERATION

On connection of the AC power or the optional DC power supply to the module, the module becomes active.

**NOTE:-**The following description of operation assumes that the optional DC supply is used.

## 1.1 CONTROL

Control of the **530** module is by a four position rotary key-switch, mounted on the front of the module with **AUTO**, **AUTO WITH MANUAL RESTORE** and **MANUAL RUN ON LOAD** and **OFF-LOAD** positions.

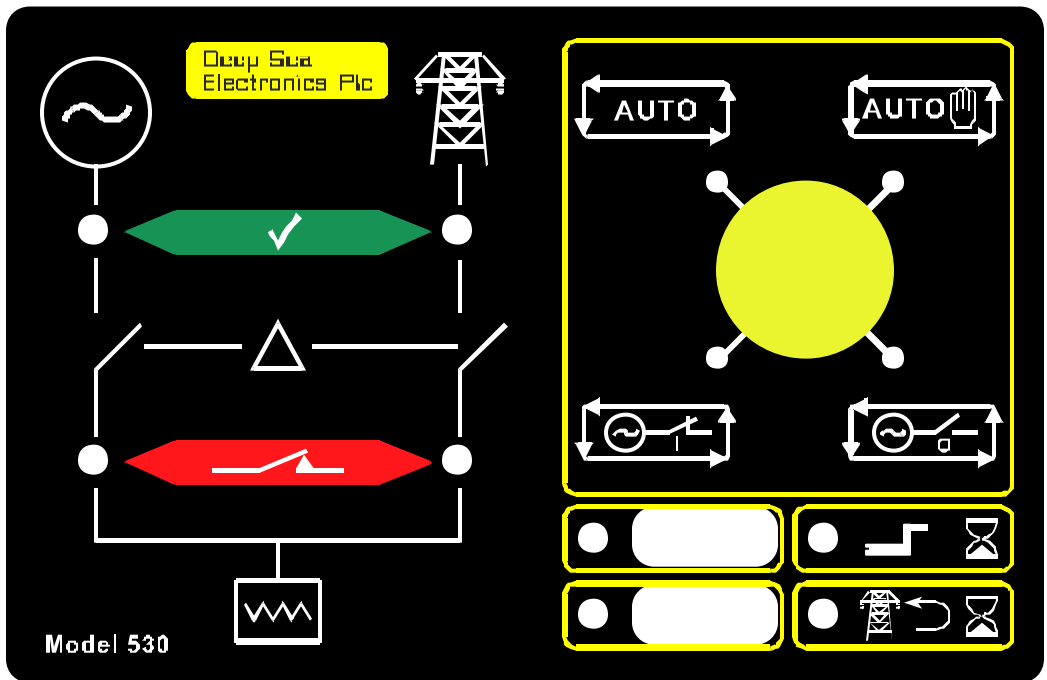

**FIG 1 - FRONT PANEL LAYOUT**

## 1.2 AUTOMATIC MODE OF OPERATION



If the module is placed in '**AUTO**' mode, it will monitor the incoming mains supply. Should the incoming mains supply fail (or fall outside of pre-set limits), the following sequence will occur.

The module will start its '**Start Delay**' timer, this is used to ensure that the start event is really required and the failure is not just a momentary dip in the supply. Once this timer has expired the module will continue with its normal sequence.

**NOTE:-** If the Mains supply returns to within limits during the Start Delay timer the unit will return to a stand-by state.

The **start and run generator** output relay is de-energised and the relay contacts close, giving a '**Remote Start**' signal to the engine starting controller. The **generator failure timer** is also initiated at this time.

The engine starting controller will now start the generator, the **530** module will monitor the generator voltage and frequency (and an optional generator ready input) and once the monitored values are above a pre-set 'Loading' level the generator will become available. This is indicated by the illumination of the appropriate LED on the mimic diagram.

As soon as the generator is available the **warm-up timer** is initiated. Once the **warm-up timer** has expired the **Mains close signal** will be removed. The **transfer timer** will then be initiated.

Once the **transfer timer** has expired the **generator close signal** will be supplied.

On return of the mains supply to within limits, the **Mains Return delay timer** is initiated, once the timer expires the **Generator Close signal** is removed, removing the load. The **transfer timer** is then initiated, once this has expired the **Mains Close signal** is supplied. The **Cooling timer** is then initiated, allowing the engine a cooling down period off load before shutting down. Once the **Cooling timer** expires the **Start and run generator signal** is removed, bringing the generator to a stop.

Should the Mains fall out of limits during the cooling down period, the set will return on load after the **Start Delay Timer** has expired.

### 1.3 MANUAL RESTORE MODE OF OPERATION



If the module is placed in '**MANUAL RESTORE**' mode, it will monitor the incoming mains supply. Should the incoming mains supply fail (or fall outside of pre-set limits), the following sequence will occur.

The module will start its '**Start Delay**' timer, this is used to ensure that the start event is really required and the failure is not just a momentary dip in the supply. Once this timer has expired the module will continue with its normal sequence.

**NOTE:-** If the Mains supply returns to within limits during the **Start Delay** timer the unit will return to a stand-by state.

The **start and run generator** output relay is de-energised and the relay contacts close, giving a '**Remote Start**' signal to the engine starting controller. The **generator failure timer** is also initiated at this time.

The engine starting controller should now start the generator, the **530** module will monitor the generator voltage and frequency (and an optional generator ready input) and once the monitored values are above a pre-set 'Loading' level the generator will become available. This is indicated by the illumination of the appropriate LED on the mimic diagram.

As soon as the generator is available the **warm-up timer** is initiated. Once the **warm-up timer** has expired the **Mains close signal** will be removed. The **transfer timer** will then be initiated.

Once the **transfer timer** has expired the **generator close signal** will be supplied.

On return of the mains supply to within limits, the **Mains Return delay timer** is initiated, once the timer expires the **530** module will wait for a manual restore to mains. This is achieved by placing the key-switch control into the '**Auto**' position, the sequence will then continue as described in section 1.2 above. Once the transfer back to the mains supply has taken place the key-switch control may be returned to the '**Manual Restore**' position.

Should the Mains fall out of limits during the cooling down period, the set will return on load after the **Start Delay Timer** has expired.

## 1.4 MANUAL OPERATION

 **NOTE:-** The following sequence is only applicable to controllers not using external push-button control.



To initiate a start sequence in **MANUAL**, turn the selector switch to **START AND RUN GENERATOR OFF LOAD**.

 **NOTE:-** There is no Start Delay in this mode of operation unless the function has been enabled via the PC software.

The **start and run generator** output relay is de-energised and the relay contacts close, giving a 'Remote Start' signal to the engine starting controller. The **generator failure timer** is also initiated at this time.

The engine starting controller should now start the generator, the **530** module will monitor the generator voltage and frequency (and an optional generator ready input) and once the monitored values are above a pre-set 'Loading' level the generator will become available. This is indicated by the illumination of the appropriate LED on the mimic diagram.



To transfer the load from the mains supply to the generator, turn the selector switch to **START AND RUN GENERATOR ON LOAD**.

If the generator is not running the start sequence will be followed as above. As soon as the generator is available the **warm-up timer** is initiated. Once the **warm-up timer** has expired the **Mains close signal** will be removed. The **transfer timer** will then be initiated.

Once the **transfer timer** has expired the **generator close signal** will be supplied.



This will transfer the load to the generating set. To re-transfer back to the mains supply return the selector switch to the **START AND RUN GENERATOR OFF LOAD** position.

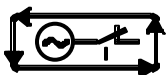

If it is required to re-load the generator, return the selector switch to the **START AND RUN GENERATOR ON LOAD** position. This sequence may be repeated as required.



To stop the generator return the selector switch to the **AUTO** position. The **generator Close signal** is removed, removing the load from the generator. The **transfer timer** is then initiated, once this has expired the **Mains Close signal** is supplied. The **Cooling timer** is then initiated, allowing the engine a cooling down period off load before shutting down. Once the **Cooling timer** expires the **Start and run generator signal** is removed, bringing the generator to a stop.

Should the Mains fall out of limits during the cooling down period, the set will return on load after the **Start Delay Timer** has expired.

## 1.5 MANUAL OPERATION WITH EXTERNAL PUSHBUTTONS

If the module has been configured to use external 'To Mains' and 'To Generator' pushbuttons the normal 'Manual' mode of operation is over-riden and the following sequence is observed;



Turn the selector switch to **START AND RUN GENERATOR OFF LOAD**.

The **start and run generator** output relay is de-energised and the relay contacts close, giving a 'Remote Start' signal to the engine starting controller. The **generator failure timer** is also initiated at this time.

The engine starting controller should now start the generator, the **530** module will monitor the generator voltage and frequency (and an optional generator ready input) and once the monitored values are above a safe 'Loading' level the generator will become available. This is indicated by the illumination of the appropriate LED on the mimic diagram.

To load the set operate the external 'To Generator' Pushbutton; the **Mains close signal** will be removed. The **transfer timer** will then be initiated. Once the **transfer timer** has expired the **generator close signal** will be supplied.

To unload the set and transfer back to the mains supply operate the external 'To Mains' Pushbutton; the **generator close signal** will be removed. The **transfer timer** will then be initiated. Once the **transfer timer** has expired the **mains close signal** will be supplied.



If the selector switch is placed in the **START AND RUN GENERATOR ON LOAD** position, the load will be transferred to the generator



If the selector switch is then returned to the **START AND RUN GENERATOR OFF LOAD** position the load will not re-transfer to the mains supply unless the external 'To Mains' pushbutton is operated



To stop the generator return the selector switch to the **AUTO** position. The **generator Close signal** is removed, removing the load from the generator. The **transfer timer** is then initiated, once this has expired the **Mains Close signal** is supplied. The **Cooling timer** is then initiated, allowing the engine a cooling down period off load before shutting down. Once the **Cooling timer** expires the **Start and run generator signal** is removed, bringing the generator to a stop.

Should the Mains fall out of limits during the cooling down period, the set will return on load after the **Start Delay Timer** has expired.

## 2. FUNCTIONS & INDICATIONS

The module status is indicated by front panel LED's. This allows for easy monitoring of system operation.

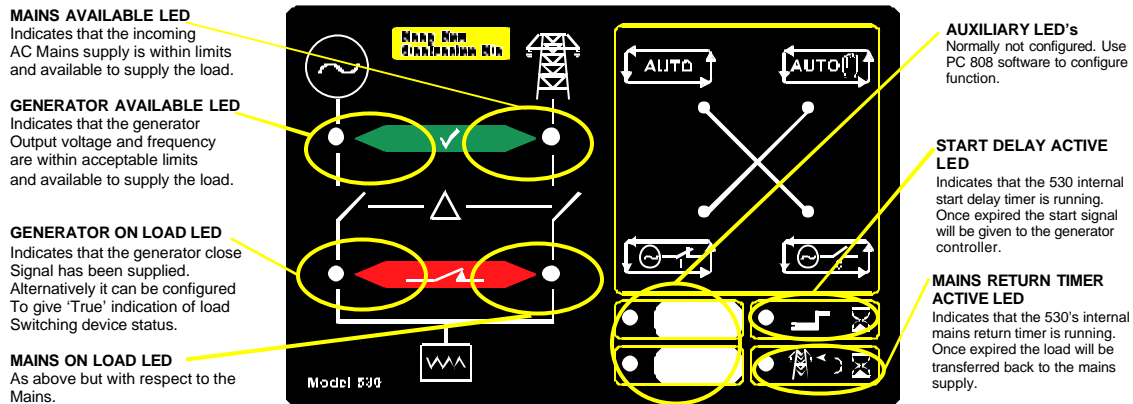

**FIG 2 - LED DESCRIPTIONS**

- NOTE 1:-**The MAINS AVAILABLE and GENERATOR AVAILABLE LED's can be re-configured to indicate a number of different functions. The default functions are GENERATOR AVAILABLE indicates generator within limits. MAINS AVAILABLE indicate NOT mains failure (mains out of limits or aux. mains fail.). For full details refer to the 808 Software Manual.
- NOTE 2:-**The GENERATOR ON LOAD and MAINS ON LOAD LED's can be re-configured to use feedback from the contactor or breaker auxiliaries to give true indication of load switching status. The default functions are:-  
GENERATOR ON LOAD indicates generator close signal active.  
MAINS ON LOAD indicates mains close signal active.  
For full details refer to the 808 Software Manual.
- NOTE 3:-** The auxiliary LED's can be used to indicate different functions which may be required. These include WARMING TIMER ACTIVE, COOLING TIMER ACTIVE, START AND RUN GENERATOR ACTIVE, MAINS FAILURE, etc. A window is provided for the user to alter the LED's description. For full details refer to the 808 Software Manual.

### 2.1 INPUT FUNCTIONS

The 530 has inputs dedicated to the functions as listed below.

**AUXILIARY GENERATOR READY**, this is a normally open (default) +ve signal. It is used to provide a confirmation signal that the generator is ready to load. The **530** will monitor the generator voltage and frequency to ensure that they are within limits, this input then provides confirmation from the generator start controller (On a **520** module the 'Load Transfer' output can be connected to this input). If this signal is not present the generator will not take load even though the output voltage and frequency are acceptable. This may be useful if other sequences occur on the generator before it is ready to load, such as smoke limiting, etc.



**AUXILIARY MAINS FAILURE**, this is a normally open (default) -ve signal. The **530** module will monitor the incoming single or three phase supply for Over voltage, Under Voltage, Over Frequency or Under frequency. It may be required to monitor a different mains supply or some aspect of the incoming mains not monitored by the **530** (such as phase rotation). If the devices providing this additional monitoring are connected to operate this input, the **530** will operate as if the incoming mains supply has fallen outside of limits, the generator will be instructed to start and take the load. Removal of the input signal will cause the module to act if the mains has returned to within limits.

**AUTO RETURN TO MAINS INHIBIT**, this is a normally open (default) -ve signal. If this input is active the **530** will operate in a similar manner to the **MANUAL RESTORE** selector switch mode. To use this function the **530** selector switch should be placed in the **AUTO** mode. In the event of a mains failure the generator will be instructed to start and take load. On main return the module will continue to run the generator on load until this **AUTO RETURN TO MAINS INHIBIT** input is removed. Once the input is removed the module will transfer the load back to the mains supply and follow a normal generator stop sequence. This input allows the **530** to be fitted as part of a system where the manual restoration to mains is controlled remotely or by an automated system.

**AUTO START INHIBIT**, this is a normally open (default) -ve signal. It is used to provide an over-ride function to prevent the **530** from calling for the generator in the event of a mains out of limits condition occurring. If this input is active and a mains failure occurs the **530** will continue to operate with the mains on load, it will not give a start command to the generator. If this input signal is then removed the **530** will operate as if a mains failure has occurred, starting and loading the generator. This function can be used to give an '**AND**' function so that a generator will only be called to start if the mains fails and another condition exists which requires the generator to run.

**MAINS CLOSED AUXILIARY INPUT**, this is a normally open (default) -ve signal. It is used to provide feedback to allow the **530** to give true indication of the contactor or circuit breaker switching status. It should be connected to the mains load switching device auxiliary contact. To use true indication via the **MAINS ON LOAD LED** the **530** will need to be reconfigured to use the **MAINS CLOSED AUXILIARY INPUT ACTIVE** state to drive this LED.

**GENERATOR CLOSED AUXILIARY INPUT**, this is a normally open (default) -ve signal. It is used to provide feedback to allow the **530** to give true indication of the contactor or circuit breaker switching status. It should be connected to the mains load switching device auxiliary contact. To use true indication via the **GENERATOR ON LOAD LED** the **530** will need to be reconfigured to use the **GENERATOR CLOSED AUXILIARY INPUT ACTIVE** state to drive this LED.

**MAINS LOAD INHIBIT**, this is a normally open (default) -ve signal. It is used to prevent the **530** from loading the mains supply. If the mains supply is already on load activating this input will cause the **530** to unload the mains supply. Removing the input will allow the mains to be loaded again.

 **NOTE:-This input only operates to control the mains switching device if the 530 load switching logic is attempting to load the mains. It will not control the mains switching device when the generator is on load.**

**GENERATOR LOAD INHIBIT**, this is a normally open (default) -ve signal. It is used to prevent the **530** from loading the generator. If the generator is already on load activating this input will cause the **530** to unload the generator. Removing the input will allow the generator to be loaded again.

 **NOTE:-This input only operates to control the generator switching device if the 530 load switching logic is attempting to load the generator. It will not control the generator switching device when the mains is on load.**

**EXTERNAL RESET/LAMP TEST**, this is a normally open (default) -ve signal. It is used to provide a test facility for the front panel indicators fitted to the **530** module. When the input is activated all

LED's should illuminate. The input also serves a second function, in that it also provides a reset signal to clear any latched alarms. The **530** has facility to provide a latched alarm on **Generator Failure** or **Mains Failure**, these latched alarms must be manually cleared if set. This is achieved by activating the reset input.

 **NOTE:-The default configuration does not use the latched alarms and if required they need to be set using the 808 PC software.**

**TRANSFER TO MAINS BUTTON**, this is a normally open (default) -ve signal. It is used to transfer the load to the mains supply when running in **START AND RUN GENERATOR OFF LOAD MODE**.

 **NOTE:-The default configuration has transfer by pushbutton disabled. If this function is required the 530 module must be reconfigured using the 808 PC software.**

**TRANSFER TO GENERATOR BUTTON**, this is a normally open (default) -ve signal. It is used to transfer the load to the generator when running in **START AND RUN GENERATOR OFF LOAD MODE**.

 **NOTE:-The default configuration has transfer by pushbutton disabled. If this function is required the 530 module must be reconfigured using the 808 PC software.**

## 2.2 OUTPUT FUNCTIONS

The **530** module is fitted with a number of relay output. The default functions are as detailed below, if other functions are required the module can be reconfigured using the **808 PC software**.

**START AND RUN GENERATOR**, normally closed volt free contact. This output supplies the **start and run signal** to the generator automatic start controller. The volt free configuration allows it to be used with different starting controllers or custom built panels. The relay will activate whenever the **530** calls for the generator to start. If the **530** stops the generator, this output will become inactive.

 **NOTE:- The Start and Run Relay is normally closed to enable the 530 to operate without a DC supply present. Loss of both AC and DC supply will result in the relay being closed.**

**CLOSE MAINS RELAY**, normally closed volt free contact. This output supplies the close signal to the mains contactor or breaker. The volt free configuration allows it to be used with different types of switching device. The relay will activate whenever the **530** calls for the mains supply to be loaded. When the **530** unloads the mains supply this output will become inactive.

 **NOTE:- The Close Mains Relay is normally closed to enable the 530 to operate without a DC supply present. Loss of both AC and DC supply will result in the relay being closed.**

**CLOSE GENERATOR RELAY**, normally open volt free contact. This output supplies the close signal to the generator contactor or breaker. The volt free configuration allows it to be used with different types of switching device. The relay will activate whenever the **530** calls for the generator to be loaded. When the **530** unloads the generator this output will become inactive.

**AUXILIARY 1 RELAY**, normally open volt free contact. This output can be configured for a number of different functions or used to control tripping of circuit breakers, etc. The default configuration for the **530** module has this output set as **GENERATOR FAILURE ALARM**. If for any reason the generator fails to become available within a pre-set time (fail to start for example) or falls out of limits when

loaded, this output will be activate. Should the generator the become available the output will become in-active.

**AUXILIARY 2 RELAY**, change-over volt free contact. This output can be configured for a number of different functions or used to control tripping of circuit breakers, etc. The change over configuration allows for suitable fail safe operation. The default configuration for the **530** module has this output set as **MAINS FAILURE ALARM**. If for any reason the mains fails or falls out of limits this output will be activate. Should the mains return the output will become in-active.

 **NOTE:- If it is required to change the function of the auxiliary relays it is possible to reconfigure the 530 module using the 808 PC software.**

### 2.3 AC ONLY OPERATION FUNCTION

The **530** has a self seeking power supply which will power the module from the **Mains AC supply**, the **Generator AC supply** or from the optional **DC supply**.

If the module is operated with AC supplies only then operation will follow that described above with the exception of '**Auto**' or '**Manual Restore**' mode operation in the event of a main failure.

If the module is placed in '**Auto**' or '**Manual Restore**' mode, it will monitor the incoming mains supply. Should the incoming mains supply fail (or fall outside of pre-set limits), the following sequence will occur.

The module will enter it's '*dead*' state and the **start and run generator** output relay is de-energised and the relay contacts close, giving a '**Remote Start**' signal to the engine starting controller.

 **NOTE:- The Start Delay timer in this instance is not used. If a start delay is required this must be provided by the generator start controller.**

The engine starting controller should now start the generator, the **530** module will seek **generator AC supply** to power itself and then monitor the generator voltage and frequency (and an optional generator ready input) and once the monitored values are above a safe 'Loading' level the generator will become available. This is indicated by the illumination of the appropriate LED on the mimic diagram. Operation of the **530** will now follow as described previously.

As soon as the generator is available the **warm-up timer** is initiated. Once the **warm-up timer** has expired the **Mains close signal** will be removed. The **transfer timer** will then be initiated.

Once the **transfer timer** has expired the **generator close signal** will be supplied.

 **NOTE:- If the Mains supply returns the 530 module will then have two AC supplies available. Therefore operation on mains return will follow that described previously.**

On return of the mains supply to within limits, the **Mains Return delay timer** is initiated, once the timer expires the **Generator Close signal** is removed, removing the load. The **transfer timer** is then initiated, once this has expired the **Mains Close signal** is supplied The **Cooling timer** is then initiated, allowing the engine a cooling down period off load before shutting down. Once the **Cooling timer** expires the **Start and run generator signal** is removed, bringing the generator to a stop.

Should the Mains fall out of limits during the cooling down period, the set will return on load after the **Start Delay Timer** has expired.

### 3. INSTALLATION INSTRUCTIONS

The model **530** ATS control Module has been designed for front panel mounting. Fixing is by 2 spring loaded clips for easy assembly.

#### 3.1 PANEL CUT-OUT

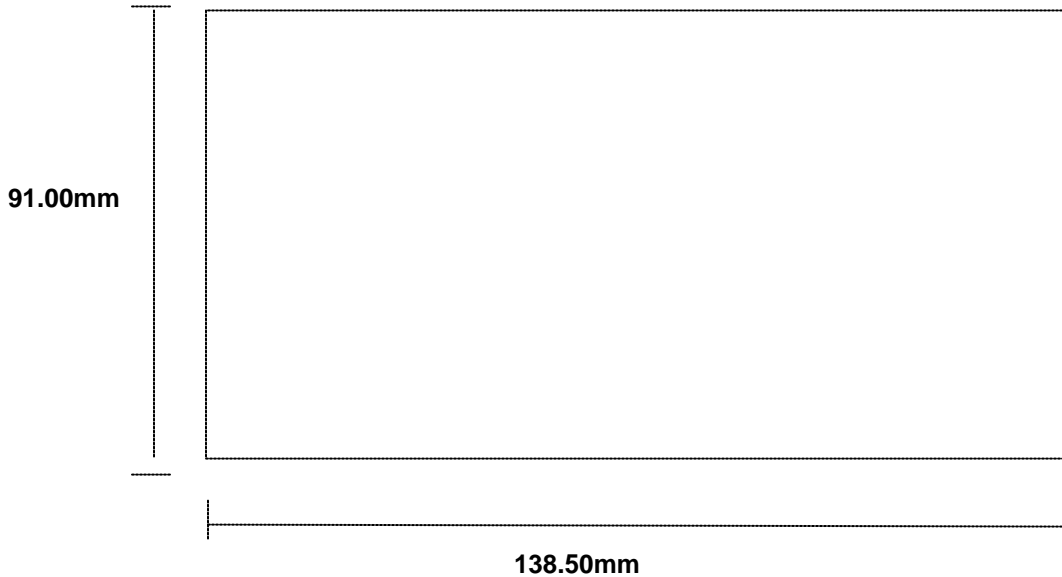

**FIG 3 - CUT-OUT DIMENSIONS**

In conditions of excessive vibration the module should be mounted on suitable anti-vibration mountings.

#### 3.2 COOLING

The module has been designed to operate over a wide temperature range **-15 to +55° C**. However allowances should be made for the temperature rise within the control panel enclosure. Care should be taken **NOT** to mount possible heat sources near the module unless adequate ventilation is provided. The relative humidity inside the control panel enclosure should not exceed **85%**.

#### 3.3 UNIT DIMENSIONS

All dimensions in mm.

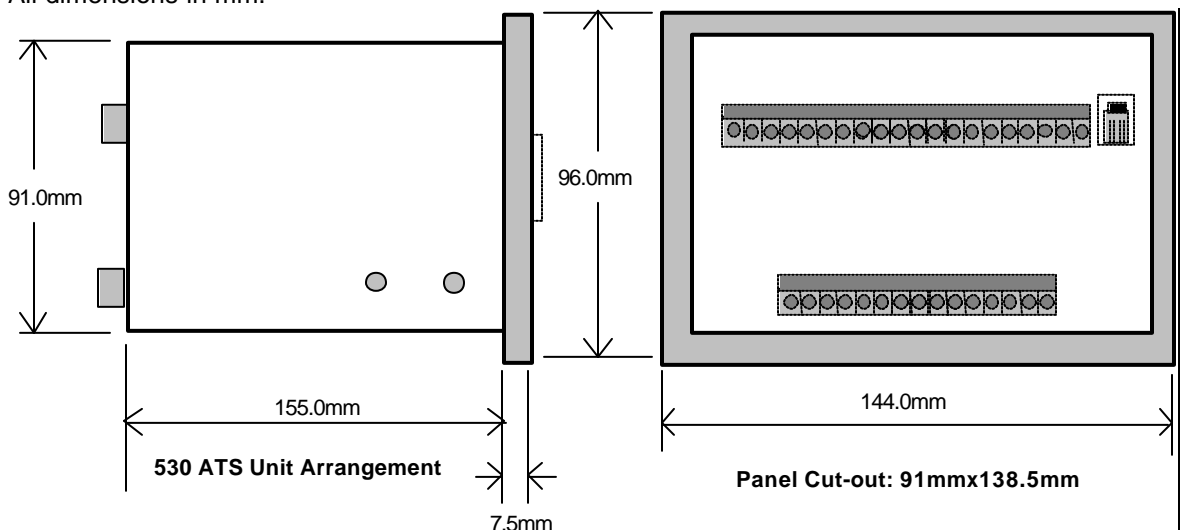

**FIG 4 - DIMENSIONS**

### 3.4 FRONT PANEL LAYOUT

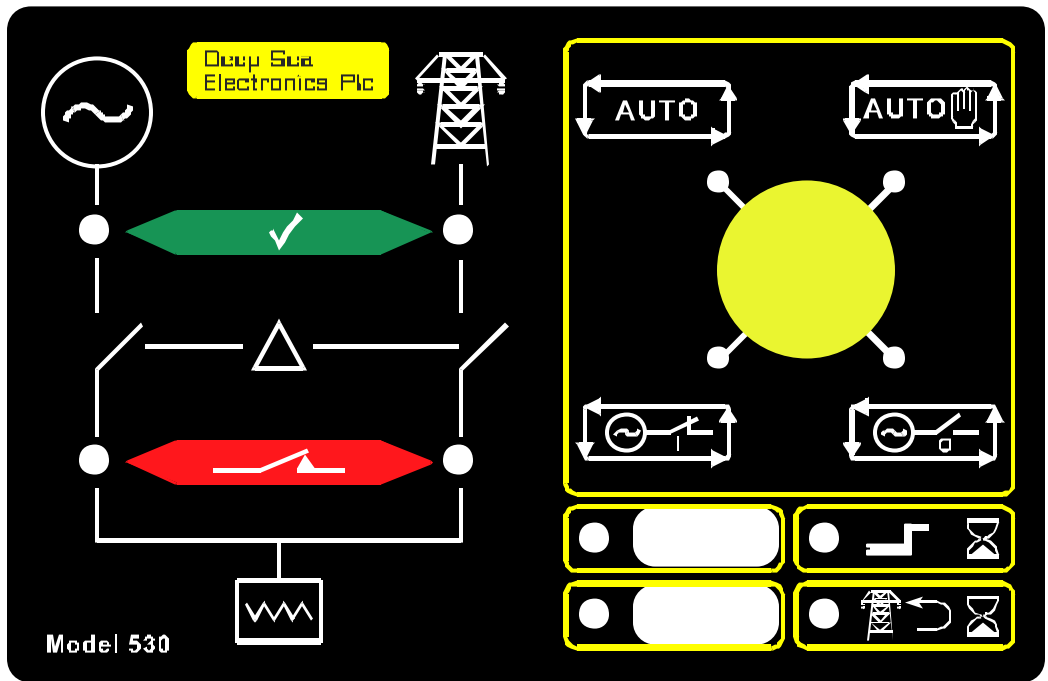

FIG 5 - FRONT PANEL

### 3.5 REAR PANEL LAYOUT

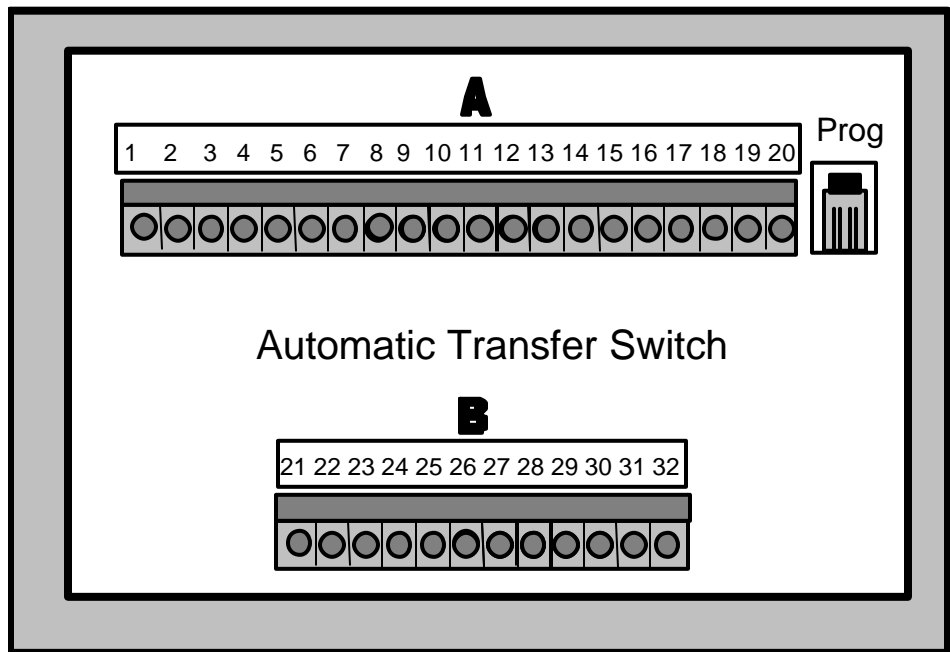

FIG 6 - REAR PANEL

## 4. ELECTRICAL CONNECTIONS

Connections to the 530 Module are via plug and sockets.

### 4.1 CONNECTION DETAILS

The following describes the connections and recommended cable sizes to the 2 plugs and sockets on the rear of the 530 Module. See rear panel layout FIG 5.

#### PLUG "A" 20WAY

PIN No	DESCRIPTION	CABLE SIZE	NOTES
1	DC Plant Supply Input (+ve)	2.5mm	(Recommended Fuse 6A)
2	DC Plant Supply Input (-ve)	2.5mm	
3	Auxiliary Relay 1	2.5mm	Voltage Free contact, normally open. NOT RATED FOR MAINS VOLTAGE.
4	Auxiliary Relay 1	2.5mm	Voltage Free contact, normally open. NOT RATED FOR MAINS VOLTAGE.
5	Start/Run Generator	2.5mm	Voltage Free contact, normally closed. NOT RATED FOR MAINS VOLTAGE.
6	Start/Run Generator	2.5mm	Voltage Free contact, normally closed. NOT RATED FOR MAINS VOLTAGE.
7	Auxiliary Relay 2	2.5mm	Voltage Free contact, normally closed. NOT RATED FOR MAINS VOLTAGE.
8	Auxiliary Relay 2	2.5mm	Voltage Free contact, common. NOT RATED FOR MAINS VOLTAGE.
9	Auxiliary Relay 2	2.5mm	Voltage Free contact, normally closed. NOT RATED FOR MAINS VOLTAGE.
10	Auxiliary generator ready input	0.5mm	Switch to +ve. Signal from gen-start module that generator is available.
11	Auxiliary mains failure input	0.5mm	Switch to -ve. Signal from additional mains monitoring devices.
12	Auto Return to mains inhibit input	0.5mm	Switch to -ve. Signal to prevent return to mains supply on mains restoration until required.
13	Auto start inhibit input	0.5mm	Switch to -ve. Signal to prevent calling for generator in the event of mains out of limits condition.
14	Mains closed auxiliary input	0.5mm	Switch to -ve. Provides contactor/circuit - breaker auxiliary feedback.
15	Generator closed auxiliary input	0.5mm	Switch to -ve. Provides contactor/circuit breaker auxiliary feedback.
16	Mains load inhibit input	0.5mm	Switch to -ve. Prevents the mains being loaded until required.
17	Generator load inhibit input	0.5mm	Switch to -ve. Prevents the generator being loaded until required.
18	External reset/Lamp test input	0.5mm	Switch to -ve. Clears latched alarms and performs lamp test function.
19	Transfer to mains push-button input	0.5mm	Switch to -ve. Allows push-button contactor or breaker control.
20	Transfer to generator push-button input	0.5mm	Switch to -ve. Allows push-button contactor or breaker control.

## PLUG "B" 12 WAY

PIN No	DESCRIPTION	CABLE SIZE	NOTES
21	Mains contactor close relay	1.0mm	Voltage free contact. Normally closed.
22	Mains contactor close relay	1.0mm	Voltage free contact. Normally closed.
23	DO NOT USE		Ensure no connection is made to this pin.
24	Mains Input Live L3	1.0mm	Incoming AC mains supply. Recommended fuse 2A.
25	Mains Input Live L2	0.5mm	Incoming AC mains supply. Recommended fuse 2A.
26	Mains Input Live L1	0.5mm	Incoming AC mains supply. Recommended fuse 2A
27	Mains Input Neutral	0.5mm	Incoming AC mains supply.
28	Generator Input Neutral	0.5mm	Incoming Generator supply.
29	Generator Input L1	0.5mm	Optional, specified on ordering. Tachometer must be completely isolated.
30	DO NOT USE		Ensure no connection is made to this pin
31	Generator contactor close relay	1.0mm	Voltage free contact, normally open.
32	Generator contactor close relay	1.0mm	Voltage free contact, normally open.

## 4.2 CONNECTOR FUNCTION DETAILS

The following describes the functions of the 2 connectors on the rear of the module. See rear panel layout FIG 6.

## PLUG "A" 20 WAY

PIN No	DESCRIPTION
1	DC Supply +ve. System DC positive input. (Battery Positive). (Optional)
2	DC Supply -ve. System DC negative input. (Battery negative). (Optional)
3	Auxiliary relay 1. A low voltage rated contact used for system status output of alternative to supply tripping signals to a circuit breaker scheme.
4	Auxiliary relay 1. A low voltage rated contact used for system status output of alternative to supply tripping signals to a circuit breaker scheme.
5	Start/Run generator contact. Signals the generator start controller to run the generator. A normally closed contact which is held open when a start is not required, ensure fail safe operation.
6	Start/Run generator contact. Signals the generator start controller to run the generator. A normally closed contact which is held open when a start is not required, ensure fail safe operation.
7	Auxiliary Relay output 2. As for Auxiliary output 1 but a change-over contact.
8	Auxiliary Relay output 2. As for Auxiliary output 1 but a change-over contact.
9	Auxiliary Relay output 2. As for Auxiliary output 1 but a change-over contact.
10	Auxiliary generator ready input. Used for the engine control module to confirm that the generator is ready to be loaded. (Optional)
11	Auxiliary Mains failure input. Used to signal an externally detect mains failure or to provide additional mains sensing capabilities. Forces a mains fail condition to occur when monitored parameter as healthy.
12	Auto return to mains inhibit input. Prevents the load being transferred back to the mains supply following a failure. Generator will remain running on load until signal is removed.



PIN No	DESCRIPTION
13	Auto-start inhibit input. Prevents the start signal from being issued if in mains falls outside of limits. Optional DC supply must be present if this function is to be used.
14	Mains closed auxiliary input. Used to connect to the contactor auxiliary contacts to give optional feedback to indicate contactor operation.
15	Generator closed auxiliary input. Used to connect to the contactor auxiliary contacts to give optional feedback to indicate contactor operation.
16	Mains Load Inhibit input. Used to prevent the mains supply from being loaded, or if on-load will cause contactor to open.
17	Generator Load Inhibit input. Used to prevent the generator from being loaded, or if on-load will cause contactor to open.
18	External reset/Lamp test input. Used to provide a lamp test facility for the LED indicators and to clear the latch alarms, (Mains Failure and Generator Failure) if used.
19	Transfer to Mains Pushbutton input. Connects to external 'To Mains' pushbutton to allow transfer of load to mains in 'Start and Run Generator off-load' mode.
20	Transfer to Generator Pushbutton input. Connects to external 'To Generator' pushbutton to allow transfer of load to generator in 'Start and Run Generator off-load' mode.

#### PLUG "B" 12 WAY

PIN No	DESCRIPTION
21	Mains Contactor Close relay output (Voltage Free). A mains rated contact used to close the mains contactor or breaker.
22	Mains Contactor Close relay output (Voltage Free). A mains rated contact used to close the mains contactor or breaker.
23	DO NOT USE
24	Mains Live input L3. Connect to the incoming mains L3 supply (if present)
25	Mains Live input L2. Connect to the incoming mains L2 supply (if present)
26	Mains Live input L1. Connect to the incoming mains L1 supply. Used for both sensing and to power the 530 module.
27	Mains Neutral input. Connect to the incoming mains supply neutral supply. Used for both sensing and to power the 530 module.
28	Generator Neutral input. Connect to the generator neutral supply. Used for both sensing and to power the 530 module.
29	Generator Live input L1. Connect to the generator L1 supply. Used for both sensing and to power the 530 module.
30	DO NOT USE
31	Generator Contactor Close relay output (Voltage free). A mains rated contact used to close the generator contactor or breaker.
32	Generator Contactor Close relay output (Voltage free). A mains rated contact used to close the generator contactor or breaker.

#### CALIBRATION SOCKET

PIN No	DESCRIPTION
1	Ground
2	Transmit Data
3	Receive Data
4	+5 Supply

 **CAUTION!:- THIS SOCKET IS FOR THE CONNECTION OF APPROPRIATE PRODUCTS MANUFACTURED BY DEEP SEA ELECTRONICS PLC ONLY, CONNECTION OF ANY OTHER DEVICE MAY CAUSE DAMAGE AND WILL INVALIDATE THE WARRANTY.**

## 5. SPECIFICATION

<b>DC Supply (Optional)</b>	8.0 to 35 V Continuous.
<b>Cranking Dropouts</b>	Able to survive 0 V for 50 mS, providing supply was at least 10 V before dropout and supply recovers to 5V
<b>Max. Operating Current</b>	150 mA at 12 V. 95 mA at 24 V.
<b>Max. Standby Current</b>	(Powered by AC supply) 34.7 mA at 115V. 16.1mA at 230V.
<b>AC Voltage Input Range (For AC only powered operation)</b>	115V Version:- 88 - 160 V ac RMS 230V Version:- 176 - 305 V ac RMS
<b>AC Frequency Input Range</b>	10 - 75 Hz
<b>AC Voltage Adjustment Range (and AC Input sensing range)</b>	115V Version:- 55 - 152 V ac RMS 230V Version:- 110 - 304 V ac RMS
<b>AC Freq. Adjustment Range</b>	10 - 75Hz
<b>Mains Rated Relay Outputs</b>	8 Amp RMS rated 1 off each NO/NC.
<b>DC Low voltage Relay Outputs</b>	8 Amp DC at supply voltage 1 off each NO/NC/CO
<b>Dimensions</b>	96 X 144 X 155 DIN (Excluding Key-switch)
<b>Operating Temperature Range</b>	-15 to +55°C

## 6. COMMISSIONING

### PRE-COMMISSIONING

Before the system is started, it is recommended that the following checks are made:-

- 6.1. The unit is adequately cooled and all the wiring to the module is of a standard and rating compatible with the system.
- 6.2. The unit **DC** supply (if used) is fused and connected direct to the battery and of correct polarity.
- 6.3. The **AC** supplies are fused and correctly connected to the appropriate feeds.

**NOTE:-** If single phase sensing is required it is possible to configure the module to monitor L1 only. Alternatively if it is not feasible to configure the module the single phase can be fed into all three phase inputs.

- 6.1. To check the **530** take appropriate measures to prevent the engine from starting (disable the operation of the fuel solenoid). After a visual inspection to ensure it is safe to proceed, connect the battery supply. Turn the selector switch to “**START AND RUN GENERATOR OFF LOAD**”.



- 6.2. The Start/run signal will be given to the generator start control which should then attempt to start the generator. Returning the **530** selector switch to either ‘**AUTO**’ position will remove the start /run signal.

- 6.1. Restore the engine to operational status (reconnect the fuel solenoid), again select “**START AND RUN GENERATOR OFF LOAD**” and this time the engine should start and once it is up to operating parameters the ‘**GENERATOR AVAILABLE LED**’ should illuminate.



- 6.1. Select ‘**START AND RUN GENERATOR ON LOAD**’ on the selector switch, the mains contactor or breaker should open and after a short delay the generator contactor or breaker should close. The generator is now on load.
- 6.2. Select ‘**AUTO**’ on the **530**. After the ‘**MAINS RETURN TIMER**’ has expired the generator contactor or breaker should open, and after a short delay the mains contactor or breaker should close. The start/run signal will be maintained for a period of time to run the generator off-load to allow it to cool. At the end of the ‘**COOLING TIMER**’ the start/run signal will be removed and the generator instructed to stop.
- 6.3. If a mains failure is simulated with the **530** in ‘**AUTO**’ mode this will have the same effect as seen in steps 6.3 and 6.4 above. Restoring the mains supply to the module will follow the same sequence as seen in 6.5 above.
- 6.4. All internal timers and selections should now be adjusted to the customers specifications or to the engine and alternator manufacturers recommendations.
- 6.5. If despite repeated checking of the connections between the **530** and the customers system, satisfactory operation cannot be achieved, then the customer is requested to contact the factory for further advice on:-

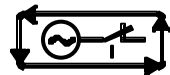

**INTERNATIONAL TEL: 44 (0) 1723 377566**  
**INTERNATIONAL FAX: 44 (0) 1723 354453**  
**E-mail: Support@Deepseapl.com**

## 7. FAULT FINDING

SYMPTOM	POSSIBLE REMEDY
Unit is inoperative	Select <b>AUTO</b> on the front panel. Check the AC mains supply to the unit. Check the AC fuses. If used check the battery and wiring to the unit. Check the DC supply. Check the DC fuse.
Unit shuts down	Check the AC supplies are within the module specification. Check that 530 module is the correct version (115V or 230V Nominal) Check DC supply voltage is not above 35 Volts or below 8 Volts. Check the operating temperature is not above 55 °C. Check the DC fuse.
Unit attempts to start the generator when mains is present.	Check AC supply to unit is in limits. Check setting on 530 module are correct. Check Auxiliary mains failure input is not active. Check configured polarity is correct.
Generator does not become available.	Check AC output is within limits. Check settings on 530 module. Check Auxiliary Generator Ready input is correctly configured and connected. Check configured polarity is correct.
No start delay timer (if used)	Check DC supply is present. Check setting on 530 module
Engine runs but generator will not take load	Check Warm up timer has timed out. Check 530 operating mode is correct.

 **NOTE:-** Fault finding can be assisted greatly by utilising the Diagnostic feature available from the PC Interface. This will display the module state, any alarm conditions present and the state of all inputs and outputs. It is recommended that diagnostics are used to aid fault finding where-ever possible.

## 8. TYPICAL WIRING DIAGRAM

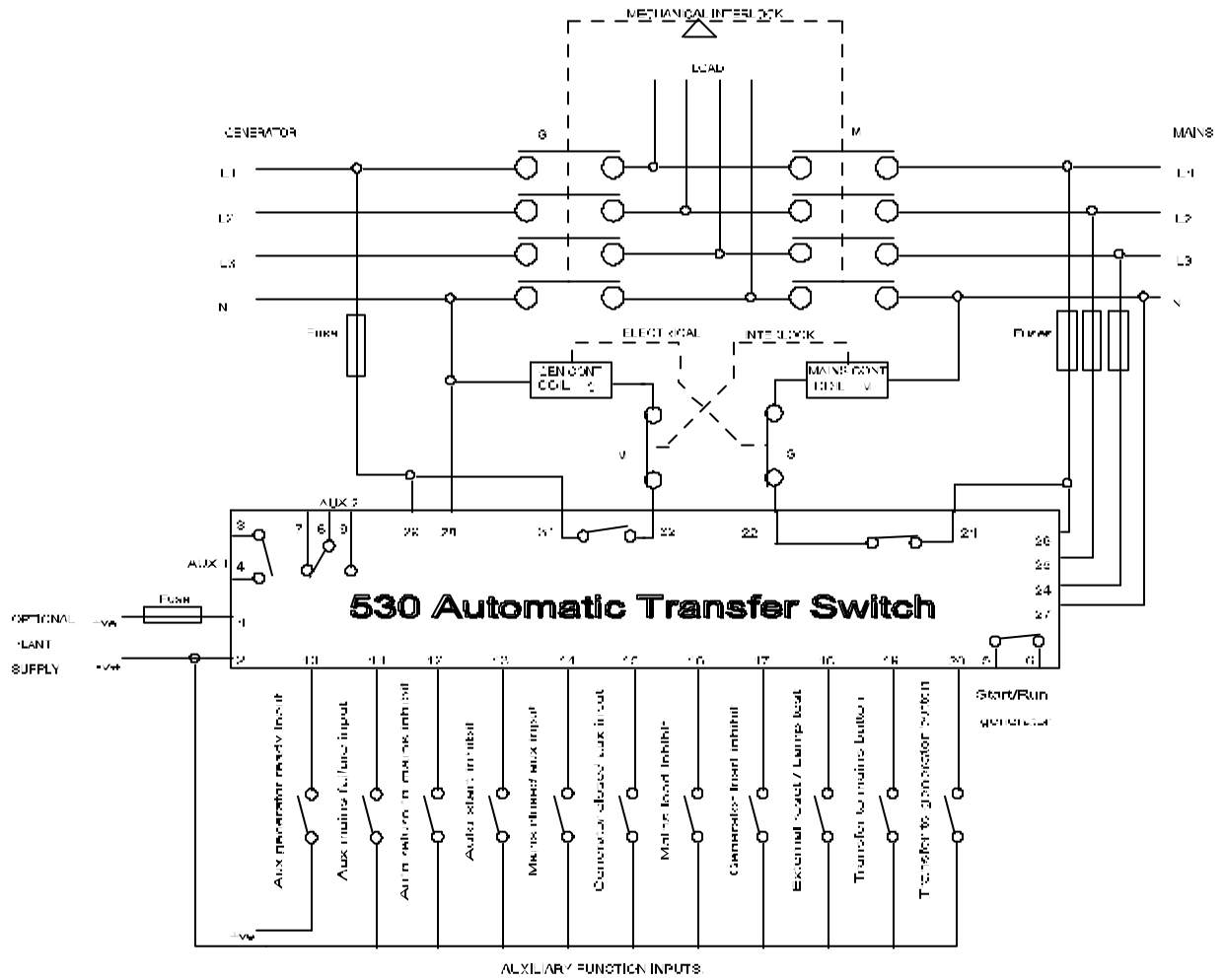

**NOTE:-** The above diagram shows a typical contactor based system. It is also possible to reconfigure the 530 module to enable connection to various breaker schemes. If unsure as to how to achieve this please refer to the 808 software manual or alternatively contact Deep Sea personnel.

**INTERNATIONAL TEL: 44 (0) 1723 377566**  
**INTERNATIONAL FAX: 44 (0) 1723 354453**  
**E-mail: Support@Deepseapl.com**

## 9. CALIBRATION

The **530** module can be calibrated by using either a PC with Interface Module **808**.

### 9.1 PC INTERFACE MODULE 808







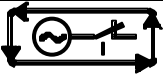

The PC interface **808** kit comprises the following:-

- **808** Interface Module
- 25 to 9 way adapter
- FCC 68 (4 Pin) Connecting Lead
- Floppy disc with configuration software

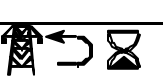
## 10. ICON DESCRIPTIONS

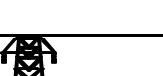
The **DSE P530** module is supplied with graphical icons instead of text. This enables the module to be used where text in the English language may cause problems and also allows for a standard module for all world markets to be used.

### 10.1 ICONS

Symbol	Meaning	Description
	Start and run generator off-load	Gives a start and run signal to the generator controller.
	Start and run generator on-load	As above, but will also transfer the load to the generator once it is available.
	Automatic mode of operation	Fully automatic operation. Giving start signal to generator on mains failure and then loading the generator. On mains return transferring back to the mains supply and stopping the generator.
	Automatic mode with manual restore to mains	As above but on mains return no action will be taken to restore to the mans supply until selector switch is returned to the 'Auto' position.
	Mains return timer active	This indicates that the mains supply has returned to within limits, but has not yet been in limits long enough for the load to transfer back to it.
	Start delay timer active	This indicates (if DC supply present) that the incoming AC mains supply has failed, but has not been out of limits long enough for a generator start to be called for.
	Mains	Indicates the incoming mans supply
	Generator	Indicates the generator which is being controlled
	Load	Indicate the load to which the Mains of the generator are being fed.
	Available	Indicates that either the mans or the generator supplies are present and within limits.
	On load	Indicates that either the mains or the generator has been selected to supply the load.

# 11. APPENDIX

## 11.1 LED IDENTIFICATION DIAGRAM

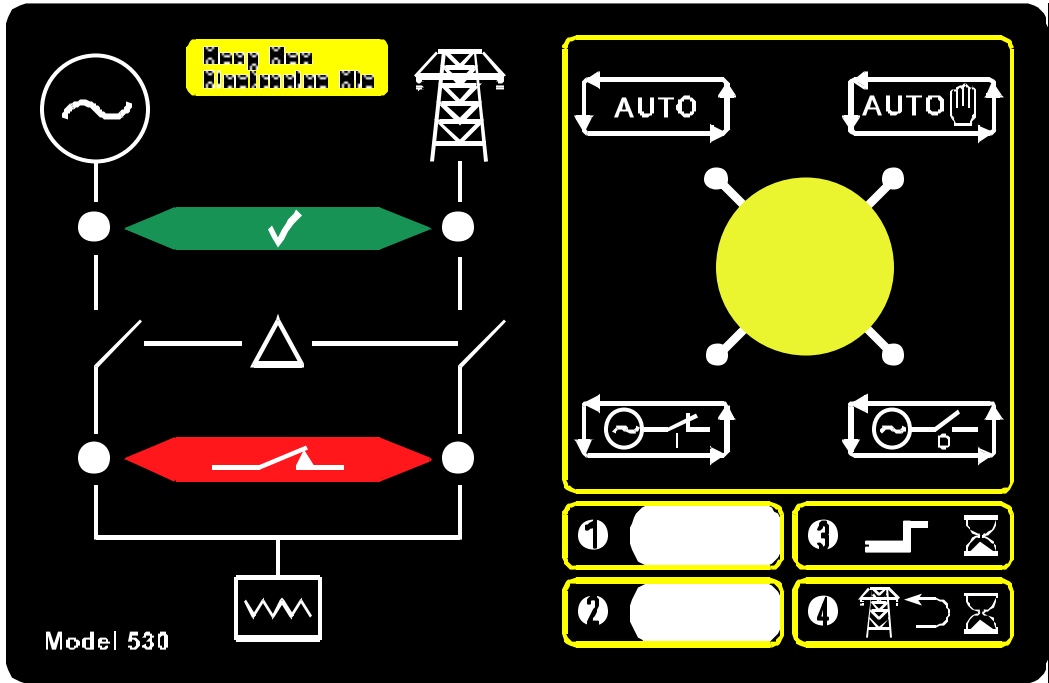

FIG 7 - AUXILIARY LED'S

**Note:-** The Software disk supplied with the Calibration Interface (808) contains a Microsoft Word document for the automatic creation of suitable label inserts for the Auxiliary LED's.

## 11.2 FACTORY DEFAULT CONFIGURATION

The 530 module when shipped contains the following configuration, allowing it to be used as a standard module if no configuration interface is available. (The 230V version is used for this example. The 115V version is similar with the exception of analogue levels.)

P53x 230V Configuration

Title: P530a 230V Config  
 Created by: Miles Revell  
 Date: 20 March 1998  
 Filename: P530A

MISCELLANEOUS ITEMS	
Item	Value
Immediate Mains Dropout	No
Start delay in manual	No
Transfer by buttons enable	No
Number of mains phases monitored	3

**CONFIGURABLE INPUTS**

Input channel	Polarity
Auxiliary generator ready	Close to activate
Auxiliary mains failure	Close to activate
Auto return to mains inhibit	Close to activate
Mains closed auxiliary	Close to activate
Generator closed auxiliary	Close to activate
External rest / lamp test	Close to activate
Transfer to mains button	Close to activate
Transfer to generator button	Close to activate

**RELAY OUTPUTS**

Output channel	Polarity	Control source
Start/run generator (NC)	De-energize	2 Start and run generator
Auxiliary relay 1 (NO)	Energize	7 Generator failure (unlatched)
Auxiliary relay 2 (CO)	De-energize	13 Mains failure (unlatched)
Close Generator (NO)	Energise	18 Close generator
Close Mains (NC)	De-energise	17 Close mains
Expansion output 1	Energise	0 Unused
Expansion output 2	Energise	0 Unused
Expansion output 3	Energise	0 Unused
Expansion output 4	Energise	0 Unused
Expansion output 5	Energise	0 Unused
Expansion output 6	Energise	0 Unused
Expansion output 7	Energise	0 Unused
Expansion output 8	Energise	0 Unused

**FRONT PANEL LED'S**

LED	Polarity	Control source
Generator available	Lit	53 Gen. Available (immediate)
Generator on load	Lit	18 Close generator
Mains available	Not Lit	13 Mains failure (unlatched)
Mains on load	Lit	17 Close mains
LED 1	Lit	0 Unused
LED 2	Lit	0 Unused
LED 3	Lit	1 Start delay
LED 4	Lit	5 Mains returning

**SYSTEM TIMERS**

Timer	Mins:secs
Start delay time	0:05
Mains return time	0:10
Transfer delay time	0:01
Generator fail delay time	0:45
Warm up time	0:00
Cooling time	0:00
Mains transient ignore time	0:02
Generator transient ignore time	0:02
Breaker close pulse time	0:00.5
Breaker trip pulse time	0:00.5

**ANALOGUE LEVELS**

Level	Value
Mains over frequency trip	55.0 Hz
Mains over frequency hysteresis	3.0 Hz
Mains under frequency trip	45.0 Hz
Mains under frequency hysteresis	3.0 Hz
Mains over voltage trip	276.0 V
Mains over voltage hysteresis	23.0V
Mains under voltage trip	184.0V
Mains under voltage hysteresis	23.0 V



Generator under frequency trip	40.0Hz
Generator loading frequency	45.0Hz
Generator under voltage trip	184.0V
Generator loading voltage	207.0V



# Deep Sea Electronics Plc CUSTOMER BULLETIN

## Recommended Configuration for 530 Modules

### DETAILS

This document is intended to clarify the function of the 530 module in specific switching applications.

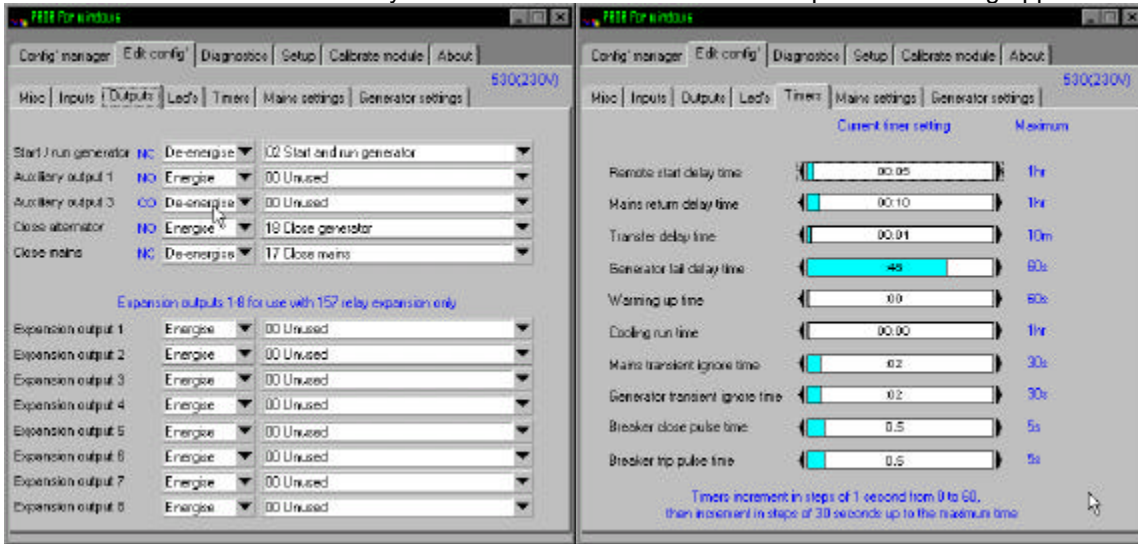

#### Output Control Source Selection

Continuous Close and Trip Signals Required	Pulsed Close and Trip Signals required
<b>Close Mains</b> Set Mains relay to de-energise using 'CLOSE MAINS'	<b>Close Mains</b> Set Mains relay to de-energise using 'CLOSE MAINS PULSE'
<b>Trip Mains (if required)</b> Set an Auxiliary relay to de-energise using 'CLOSE MAINS'	<b>Trip Mains</b> Set an Auxiliary relay to energise using 'TRIP MAINS PULSE'
<b>Close Generator</b> Set Alternator relay to energise on 'CLOSE GENERATOR'	<b>Close Generator</b> Set Alternator relay to energise on 'CLOSE GENERATOR PULSE'
<b>Trip Generator (if required)</b> Set an Auxiliary relay to de-energise on 'CLOSE GENERATOR'	<b>Trip Generator</b> Set an Auxiliary relay to de-energise on 'TRIP GENERATOR PULSE'
<p><b>NOTE:-</b> There are no special Timer requirements with the above scheme.</p> <p>(For details on setting the outputs please refer to either the P808 Software Manual or the P808 For Windows Software Manual and the P530 Operators Manual)</p>	<p><b>WARNING!:-</b> The above scheme requires some consideration of the timer settings to function correctly. The 'breaker trip pulse timer' cannot be longer than the 'Transfer delay timer'. Therefore it is important to ensure that the 'Transfer delay timer' setting is equal to or greater than the 'breaker trip</p>

*pulse timer'.*