

Deep Sea Electronics Plc

MODEL 521 REMOTE START ENGINE MANAGEMENT SYSTEM

Author:- Miles Revell

**Deep Sea Electronics Plc
Mountside Park
Queen Margarets Road
Scarborough
North Yorkshire
YO11 2RH
England
Tel: +44 (0) 1723 377566
Fax: +44 (0) 1723 354453
E-Mail: Sales@Deepseapl.com**

TABLE OF CONTENTS

Section	Page
INTRODUCTION.....	3
CLARIFICATION OF NOTATION USED WITHIN THIS PUBLICATION.....	3
1. OPERATION.....	4
1.1 CONTROL.....	4
FIG 1.....	4
1.2 AUTOMATIC MODE OF OPERATION.....	4
1.3 MANUAL OPERATION.....	5
MANUAL OPERATION WITH EXTERNAL START AND STOP PUSHBUTTONS.....	6
2. PROTECTIONS.....	7
2.1 WARNINGS.....	7
2.2 SHUTDOWNS.....	7
3. INSTALLATION INSTRUCTIONS.....	9
3.1 PANEL CUT-OUT.....	9
FIG 2.....	9
3.2 COOLING.....	9
3.3 UNIT DIMENSIONS.....	9
FIG 3.....	9
3.4 FRONT PANEL LAYOUT.....	10
FIG 4.....	10
3.5 REAR PANEL LAYOUT.....	10
FIG 5.....	10
4. ELECTRICAL CONNECTIONS.....	11
4.1 CONNECTION DETAILS.....	11
PLUG "A" 13 WAY.....	11
PLUG "B" 10 WAY.....	11
4.2 CONNECTOR FUNCTION DETAILS.....	12
PLUG "A" 13 WAY.....	12
PLUG "B" 10 WAY.....	12
CALIBRATION SOCKET.....	13
5. SPECIFICATION.....	13
6. COMMISSIONING.....	14
PRE-COMMISSIONING.....	14
7. FAULT FINDING.....	15
8. TYPICAL WIRING DIAGRAM.....	16
9. CALIBRATION.....	17
9.1 PC INTERFACE MODULE 808.....	17
10. ICON DESCRIPTIONS.....	17
10.1 ICONS.....	17
11. APPENDIX.....	18
11.1 LED IDENTIFICATION DIAGRAM.....	18
FIG 6.....	18
11.2 FACTORY DEFAULT CONFIGURATION.....	18

INTRODUCTION

The DSE **521** Remote Start Module, has been designed to allow the OEM to meet most of the industry's complex specifications. It has been primarily designed to start a generator when a remote start signal from a remote transfer switch or other monitoring system applies an earthing signal to the remote start input of the **521**. Transfer the load to the generator when the operating criteria have been met, then shutdown the engine on removal of the remote start signal.

Once activated the **521** module carries out all the start and stop procedures of the engine, indicating the operational status and fault conditions; automatically shutting down the engine and giving a true first up fault condition of an engine failure by a flashing LED and other simultaneous faults by a steady LED. This information is indicated by the LED's on the front panel.

Selective operational sequences, timers and alarm trips can be altered by the customer. Alterations to the system are made by using a PC with the **808** interface.

Access to critical operational sequences and setting for use by qualified engineers, are barred by a security code. Timers are protected by a separated code allowing operator changes to be made.

The module is housed in a robust plastic case for the front panel mounting. Connections to the module are via locking plug and sockets.

CLARIFICATION OF NOTATION USED WITHIN THIS PUBLICATION.

 **NOTE:**

Highlights an essential element of a procedure to ensure correctness.

 **CAUTION!:**

Indicates a procedure or practice which, if not strictly observed, could result in damage or destruction of equipment.

 **WARNING!:**

Indicates a procedure or practice which could result in injury to personnel or loss of life if not followed correctly.

ã

DEEP SEA ELECTRONICS PLC own the copyright to this manual, which cannot be copied, reproduced or disclosed to a third party without prior written permission.

1. OPERATION

On connection of the DC power supply to the module, the module becomes active. This is indicated by the Power On LED illuminating.

1.1 CONTROL

Control of the **521** module is by a three position rotary switch or key-switch (specified on ordering), mounted on the front of the module with **OFF**, **AUTO** and **MANUAL** positions.

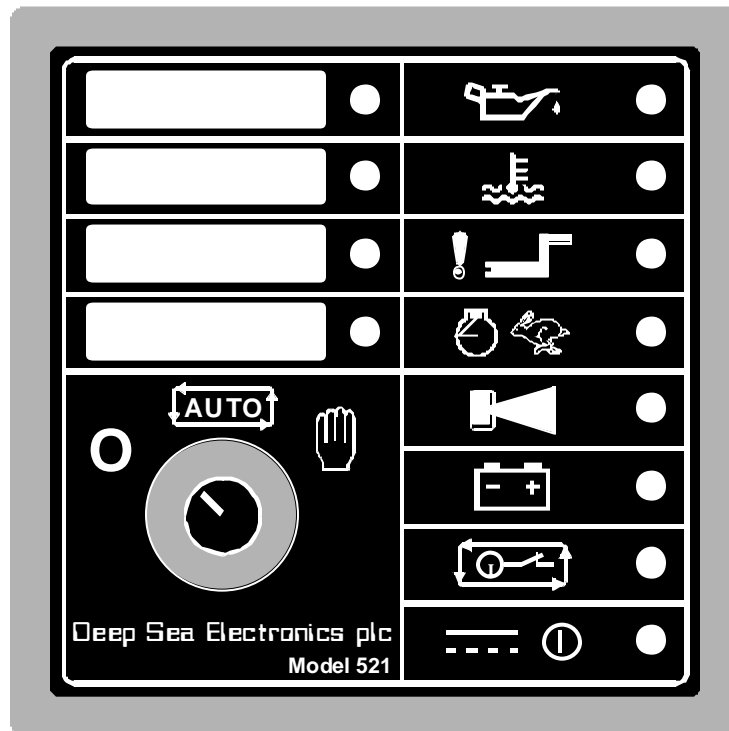

FIG 1

1.2 AUTOMATIC MODE OF OPERATION

The module is activated by turning the selector switch to the **AUTO** position.

When a **Remote Start** signal is applied to the remote start input, the following sequence is initiated:-

The **Remote Start Present LED** illuminates.

To allow for false signals the **Start Delay** timer is initiated, after this delay, if the **pre-heat** output option is selected this timer is then initiated, and the corresponding auxiliary output which is selected energises.

NOTE:- If the Remote Start signal is removed during the Start Delay timer the unit will return to a stand-by state.

After the above delays the **Fuel Solenoid** is energised, then the **Starter Motor** is engaged.

The engine is cranked for a pre-set time period. If the engine fails to fire during this cranking attempt then the starter motor is disengaged for the pre-set rest period. Should this sequence continue beyond the set number of attempts, the start sequence will be terminated and **Fail to Start** fault will be displayed by a flashing **LED**.

When the engine fires, the starter motor is disengaged and locked out at a pre-set frequency from the Alternator output. Alternatively a Magnetic Pickup mounted on the flywheel housing can be used for speed detection. (This is selected by PC using the **808** interface.) The warning lamp output of the charge alternator can also be used to disconnect the starter motor, however it cannot be used for underspeed or overspeed. This is explained in the calibration section.

After the starter motor has disengaged, the **Safety On** timer is activated, allowing Oil Pressure, High Engine Temperature, Underspeed, Charge Fail and any delayed Auxiliary fault inputs to stabilise without triggering the fault.

Once the engine is running, the **Warm Up** timer, if selected is initiated, allowing the engine to stabilise before accepting the load.

If an auxiliary output has been selected to give a **load transfer** signal, this would then activate.

 **NOTE:-A load transfer will not be initiated until the Oil Pressure has risen and the Oil Pressure switch has operated. Thus preventing excessive wear on the engine.**

On removal of the **Remote Start** signal, the **Stop** delay timer is initiated, once it expires the **load Transfer** signal is de-energised, removing the load. The **Cooling** timer is then initiated, allowing the engine a cooling down period off load before shutting down. Once the **Cooling** timer expires the **Fuel Solenoid** is de-energised, bringing the generator to a stop.

Should the **Remote Start** signal be re-activated during the cooling down period, the set will return on load after the Warming Timer has expired.

1.3 MANUAL OPERATION

 **NOTE:- The following sequence is only applicable to controllers not using external start/stop push-button control.**

To initiate a start sequence in **MANUAL**, turn the selector switch to **MANUAL**.

 **NOTE:- There is no Start Delay in this mode of operation.**

If the **pre-heat** output option is selected this timer is then initiated, and the auxiliary output selected is energised.

After the above delay the **Fuel Solenoid** is energised, then the **Starter Motor** is engaged.

The engine is cranked for a pre-set time period. If the engine fails to fire during this cranking attempt then the starter motor is disengaged for the pre-set rest period. Should this sequence continue beyond the set number of attempts, the start sequence will be terminated and **Fail to Start** fault will be displayed by a flashing **LED**.

When the engine fires, the starter motor is disengaged and locked out at a pre-set frequency from the Alternator output. Alternatively a Magnetic Pickup mounted on the flywheel housing can be used for speed detection. (This is selected by PC using the **808** interface.) The warning lamp output of the charge alternator can also be used to disconnect the starter motor, however it cannot be used for underspeed or overspeed.

After the starter motor has disengaged, the **Safety On** timer is activated, allowing Oil Pressure, High Engine Temperature, Underspeed, Charge Fail and any delayed Auxiliary fault inputs to stabilise without triggering the fault.

Once the engine is running, the **Warm Up** timer, if selected is initiated, allowing the engine to stabilise before it can be loaded.

The generator will run off load, unless a **Remote Start** signal is applied, and if **Load Transfer** has been selected as a control source, the appropriate auxiliary output selected will active.

If the **Remote Start** signal is removed, the generator will continue to run **On** load until the selector switch is turned to **Auto**. The **Remote Stop Delay Timer** will time out, the load is then disconnected. The generator will then run **off** load allowing the engine a **cooling** down period.

Turning the selector to **STOP** de-energises the **FUEL SOLENOID**, bringing the generator to a stop.

MANUAL OPERATION WITH EXTERNAL START AND STOP PUSHBUTTONS

If the module has been configured to use external Start and Stop pushbuttons the normal 'Manual' mode of operation is over-riden and the following sequence is observed;

Turn the selector switch to **MANUAL**.

To start the set operate the '**Start**' Push-button, the **pre-heat** output (if selected) will energise and the timer is initiated.

Once the above delay has expired the **Fuel Solenoid** is energised, then the **Starter Motor** is engaged.

The engine is cranked for a pre-set time period. If the engine fails to fire during this cranking attempt then the starter motor is disengaged for the pre-set rest period. Should this sequence continue beyond the set number of attempts, the start sequence will be terminated and **Fail to Start** fault will be displayed by a flashing **LED**.

When the engine fires, the starter motor is disengaged and locked out at a pre-set frequency from the Alternator output. Alternatively a Magnetic Pickup mounted on the flywheel housing can be used for speed detection. (This is selected by PC using the **808** interface.) The warning lamp output of the charge alternator can also be used to disconnect the starter motor, however it cannot be used for underspeed or overspeed.

After the starter motor has disengaged, the **Safety On** timer is activated, allowing Oil Pressure, High Engine Temperature, Underspeed, Charge Fail and any delayed Auxiliary fault inputs to stabilise without triggering the fault.

Once the engine is running, the **Warm Up** timer, if selected is initiated, allowing the engine to stabilise before it can be loaded.

The generator will run off load, unless a **Remote Start** signal is applied, and then if **Load Transfer** has been selected as a control source, the appropriate auxiliary output selected will be activated.

If the **Remote Start** signal is removed, the generator will continue to run **On** load until the selector switch is turned to **Auto**. The **Remote Stop Delay Timer** will time out, the load is then disconnected. The generator will then run **off** load allowing the engine a **cooling** down period.

Turning the selector to **STOP** or pressing the '**Stop**' Pushbutton de-energises the **FUEL SOLENOID**, bringing the generator to a stop.

2. PROTECTIONS

The **LED's** will indicate the fault condition and one of the auxiliary outputs if selected to be a common alarm output, will activate. First up fault is indicated by a flashing **LED**, subsequent faults which happen simultaneously are indicated by a steady **LED**. Warnings are also indicated by a steady **LED**. Indications are fed directly from the appropriate input and are indicated by a steady **LED** which will be present for as long as the input is active, this feature can be used to allow the module to operate as an Annunciator.

 **NOTE 1:-An auxiliary output may be configured as one of three alarm options, Shutdown, Warning or Common Alarm (Shutdown and Warnings). This is in addition to the list of other control sources from which it may be driven.**

 **NOTE 2:-There is a Common alarm LED on the front panel which illuminates to indicate all Shutdown and Warning faults, this is mainly used to indicate fault conditions such as Emergency Stop, Fail to Stop, Underspeed, Sensor Fail and Oil Pressure Switch which do not have their own individual LED to indicate the fault. A warning indication is illuminated steady, while shutdown indications flash.**

 **NOTE 3:- A corrupt configuration is indicated by all the LED's flashing. The module must then be re-configured.**

2.1 WARNINGS

Warnings are self resetting, once the fault has been removed the input is reset.

CHARGE FAIL, If charge alternator voltage falls below the pre-set trip voltage after the end of safety on timer. The **Charge Fail LED** is illuminated.

AUXILIARY INPUTS, if an auxiliary input has been configured as a warning the appropriate **LED** will illuminate.

OIL PRESSURE SWITCH, the **521** will only attempt to crank the engine if the Oil Pressure is initially low, (engine at rest, not running). It is also possible that this could indicate that the Oil Pressure switch is faulty if engine not running. The **Common Alarm LED** will illuminate.

2.2 SHUTDOWNS

Shutdowns are latching and stop the Generator. The selector switch must be turned to **Stop Reset** and the fault removed to reset the module.

EMERGENCY STOP, removal of the **+ve DC** Supply from the Emergency Stop input initiates the following sequence, firstly it will initiate a controlled shutdown of the Generator and prevent any attempt to restart the Generator until the Emergency Stop push-button has been reset. Secondly it removes the **+ve DC** supply from both the Fuel Solenoid and Starter Solenoid. This input is always active when **AUTO** or **MANUAL** is selected.

 **NOTE:- The Emergency Stop signal must be present otherwise the unit will shutdown.**

LOW OIL PRESSURE, activation of the Low Oil Pressure input after the **Safety On** timer has expired, initiates a shutdown. The **Low Oil Pressure LED** will flash.

HIGH ENGINE TEMPERATURE, activation of the High Engine Temperature input after the **Safety On** timer has expired, initiates a shutdown. The **High Engine Temperature LED** will flash.

OVERSPEED, if the engine speed exceeds the pre-set trip a shutdown is initiated. The **Overspeed LED** will flash. Overspeed is not delayed, it is an **immediate shutdown**.

FAIL TO START, if the engine fails to fire after the pre-set number of attempts to crank, the start sequence is terminated. The **Fail to Start LED** will flash.

FAIL TO STOP, if the generator fails to stop after the pre-set time, the **Common Alarm LED** will flash. Two conditions must be met to signal that the generator has stopped, Oil Pressure has gone low, and that no speed is sensed from either Magnetic Pickup or Alternator speed sensing sources.

UNDERSPEED, if the engine speed falls below the pre-set trip after the **Safety On** timer has expired a shutdown is initiated. The **Common Alarm LED** will flash.

SENSOR FAIL, if the speed sensing signal is lost during cranking, the Generator will shutdown and the **Common Alarm LED** will flash.

 **NOTE:- This will only occur if the speed sensing signal is lost during cranking or during the safety on timer. If the signal is lost during normal operation the Generator will shutdown with an Underspeed alarm.**

AUXILIARY INPUTS, if an auxiliary input has been configured as a Shutdown the appropriate **LED** will illuminate.

 **NOTE:- It is possible for the LED's to be configured to indicate any of the 32 different control sources in addition to the shutdowns and warnings detail above. Please refer to the 808 Software Manual for detail on how to achieve this.**

3. INSTALLATION INSTRUCTIONS

The model 521 Remote Start Module has been designed for front panel mounting. Fixing is by 2 spring loaded clips for easy assembly.

3.1 PANEL CUT-OUT

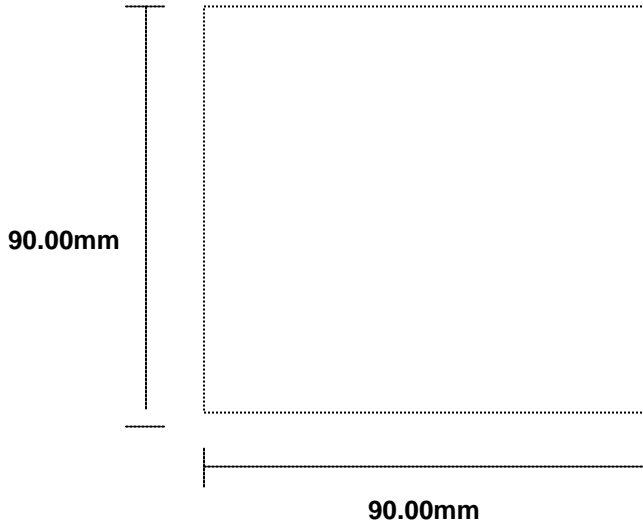

FIG 2

In conditions of excessive vibration the module should be mounted on suitable anti-vibration mountings.

3.2 COOLING

The module has been designed to operate over a wide temperature range **-30 to +55° C**. However allowances should be made for the temperature rise within the control panel enclosure. Care should be taken **NOT** to mount possible heat sources near the module unless adequate ventilation is provided. The relative humidity inside the control panel enclosure should not exceed **85%**.

3.3 UNIT DIMENSIONS

All dimensions in mm.

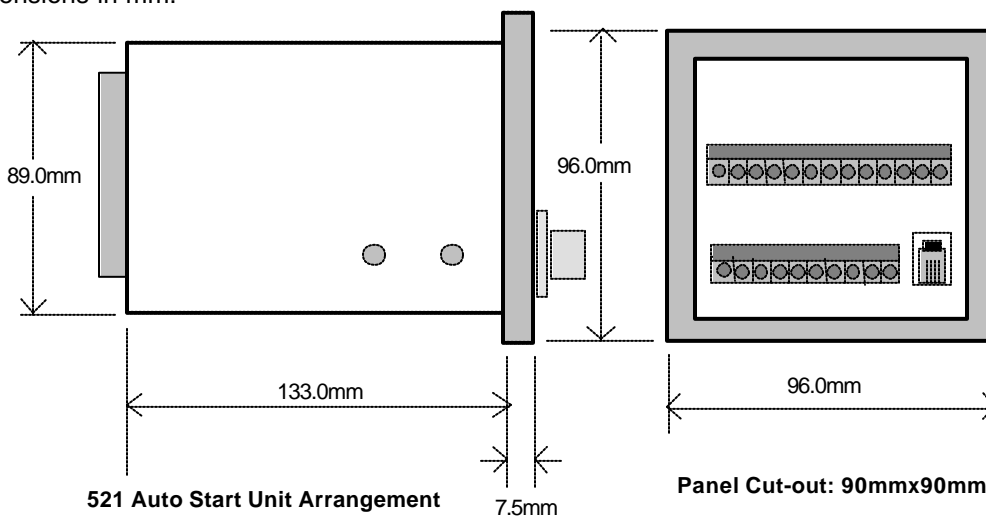

FIG 3

3.4 FRONT PANEL LAYOUT

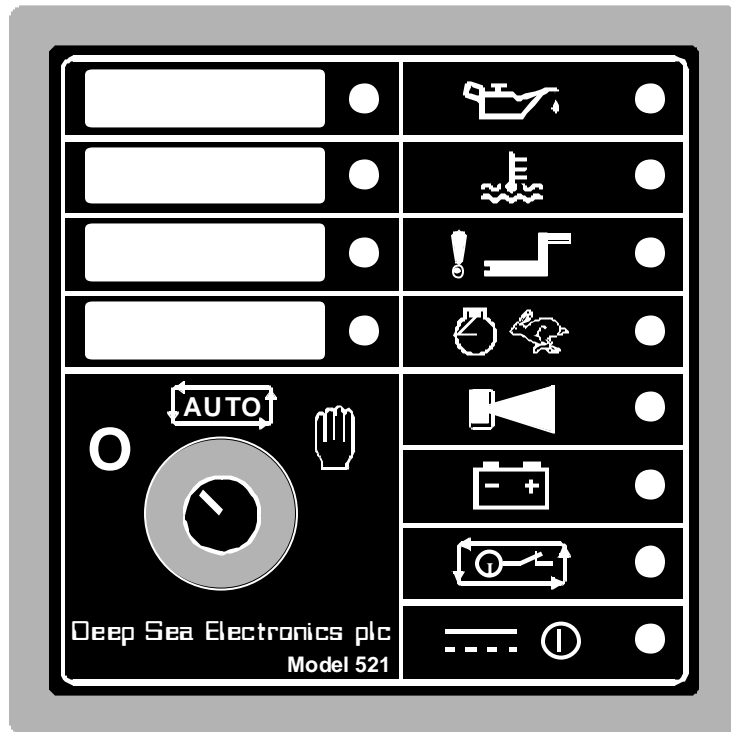

FIG 4

3.5 REAR PANEL LAYOUT

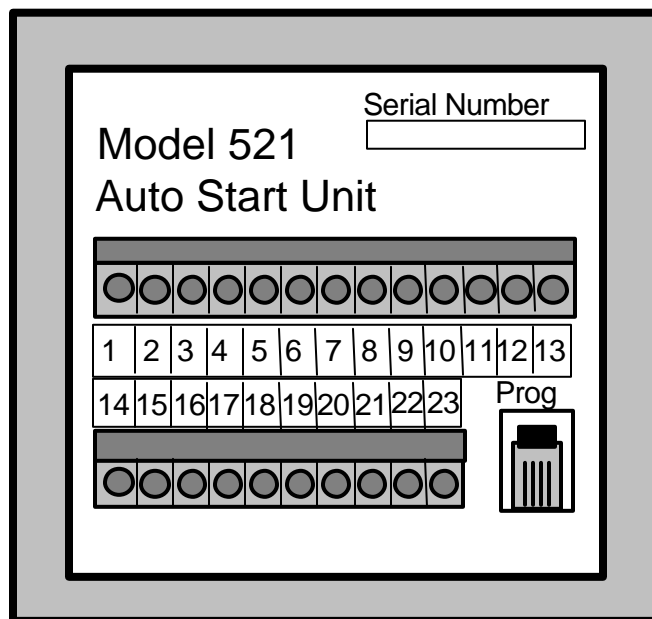

FIG 5

4. ELECTRICAL CONNECTIONS

Connections to the 521 Module are via plug and sockets.

4.1 CONNECTION DETAILS

The following describes the connections and recommended cable sizes to the 2 plugs and sockets on the rear of the 521 Module. See rear panel layout FIG 5.

PLUG "A" 13 WAY

PIN No	DESCRIPTION	CABLE SIZE	NOTES
1	DC Plant Supply Input (-ve)	2.5mm	
2	DC Plant Supply Input (+ve)	2.5mm	(Recommended Fuse 18A)
3	Emergency Stop Input	2.5mm	Plant Supply +ve. Also supplies fuel & start outputs.(Recommended Fuse 32A)
4	Fuel relay Output	2.5mm	Plant Supply +ve from pin 3. 16 Amp rated.
5	Start relay Output	2.5mm	Plant Supply +ve from pin 3. 16 Amp rated.
6	Auxiliary Output relay 1	1.0mm	Plant Supply +ve. 5 Amp rated.
7	Auxiliary Output relay 2	1.0mm	Plant Supply +ve. 5 Amp rated.
8	Charge Fail Input/Excitation Output	1.0mm	Must NOT be connected to plant supply -ve if not used.
9	Low Oil Pressure Input	0.5mm	Switch to -ve
10	High Engine Temp Input	0.5mm	Switch to -ve
11	Auxiliary Input 1	0.5mm	Switch to -ve
12	Auxiliary Input 2	0.5mm	Switch to -ve
13	Remote Start Input	0.5mm	Switch to -ve

PLUG "B" 10 WAY

PIN No	DESCRIPTION	CABLE SIZE	NOTES
14	Alternator Input L1	1.0mm	Do not connect if not used. (2A Fuse)
15	Alternator Input N	1.0mm	Do not connect if not used.
16	DO NOT USE		Ensure no connection is made to this pin.
17	Auxiliary Output 3	1.0mm	Plant Supply +ve. 5 Amp rated.
18	Auxiliary Input 3	0.5mm	Switch to -ve
19	Auxiliary Input 4	0.5mm	Switch to -ve
20	Magnetic Pickup Input (+ve)	0.5mm	Connect to Magnetic Pickup device
21	Magnetic Pickup Input (-ve)	0.5mm	Connect to Magnetic Pickup device
22	Tachometer Output (+ve)	0.5mm	Optional, specified on ordering. Tachometer must be completely isolated.
23	Tachometer Output (-ve)	0.5mm	Optional, specified on ordering. Tachometer must be completely isolated.

 **NOTE:-** Screened cable must be used for connecting the Magnetic Pickup, ensuring that the screen is earthed at one end ONLY.

4.2 CONNECTOR FUNCTION DETAILS

The following describes the functions of the 2 connectors on the rear of the module. See rear panel layout FIG 5.

PLUG “A” 13 WAY

PIN No	DESCRIPTION
1	DC Supply -ve. System DC negative input. (Battery Negative).
2	DC Supply +ve. System DC positive input. (Battery Positive).
3	Emergency Stop input. Internally linked to Starter and Fuel outputs. If this input is not connected to positive the module will be locked out, and if the engine is running will shutdown immediately. Positive Supply also removed from Starter and Fuel therefore only a single pole Emergency Shutdown button is required.
4	Fuel Relay output. Plant Supply +ve from pin 3. Used to control the fuel solenoid.
5	Starter Relay output. Plant Supply +ve from pin 3. Used to control the Starter Motor.
6	Auxiliary Relay output 1. Plant Supply +ve. Configurable output, see Calibration Manual for options available.
7	Auxiliary Relay output 2. As for Auxiliary output 1 (Pin No 6).
8	Charge Fail input / Excitation output. Supplies excitation to the Plant Battery Charging Alternator, also an input for the Charge Fail detection circuitry.
9	Low Oil Pressure input. This is a negative switched input, it is possible to calibrate the input to be a normally closed signal or a normally open signal. This input is used to signal to the module that the oil pressure is low.
10	High Engine Temperature input. This is a negative switched input, it is possible to calibrate the input to be a normally closed signal or a normally open signal. This input is used to signal to the module that the engine temperature is high.
11	Auxiliary input 1. This is a negative switched configurable input, see Calibration Manual for options available. It is possible to configure the input to be a normally closed signal or a normally open signal.
12	Auxiliary input 2. As for Auxiliary input 1 (Pin 11).
13	Remote Start input. This is a negative switched input which will start the generator when Auto is selected. It is possible to configure the input to be a normally open signal or a normally closed signal.

PLUG “B” 10 WAY

PIN No	DESCRIPTION
14	Alternator Input L1. Used for Alternator speed sensing.
15	Alternator Input N. Used for Alternator speed sensing.
16	DO NOT USE
17	Auxiliary Relay output 3. Plant Supply +ve. Configurable output, see Calibration Manual for options available.
18	Auxiliary input 3. This is a negative switched configurable input, see Calibration Manual for options available. It is possible to configure the input to be a normally closed signal or a normally open signal.
19	Auxiliary input 4. As for Auxiliary input 3 (Pin 18).
20	Magnetic Input +ve. An AC signal from the magnetic pickup +ve for speed sensing.
21	Magnetic Input -ve. An AC signal from the magnetic pickup -ve for speed sensing.
22	Tachometer output +ve. 0.5 or 1.0 mA Tachometer can be used.
23	Tachometer output -ve. ----- “ -----

CALIBRATION SOCKET

PIN No	DESCRIPTION
1	Ground
2	Transmit Data
3	Receive Data
4	+5 Supply

⚠ CAUTION!:- THIS SOCKET IS FOR THE CONNECTION OF APPROPRIATE PRODUCTS MANUFACTURED BY DEEP SEA ELECTRONICS PLC ONLY, CONNECTION OF ANY OTHER DEVICE MAY CAUSE DAMAGE AND WILL INVALIDATE THE WARRANTY.

5. SPECIFICATION

DC Supply	8.0 to 35 V Continuous.
Cranking Dropouts	Able to survive 0 V for 50 mS, providing supply was at least 10 V before dropout and supply recovers to 5V
Max. Operating Current	290 mA at 12 V. 210 mA at 24 V.
Max. Standby Current	50 mA at 12 V. 30 mA at 24 V.
Alternator Input Range	15 - 300 V ac RMS
Alternator Input Frequency	50 - 60 Hz at rated engine speed.
Magnetic Input Range	0.5 V to +/- 70 V (Clamped by transient suppressors)
Magnetic Input Frequency	10Hz to 10,000 Hz at rated engine speed.
Start Relay Output	16 Amp DC at supply voltage.
Fuel Relay Output	16 Amp DC at supply voltage.
Auxiliary Relay Outputs	5 Amp DC at supply voltage.
Dimensions	96 X 96 X 140.5 (Excluding Key-switch or Knob)
Charge Fail / Excitation Range	0 V to 35 V
Operating Temperature Range	-30 to +55°C

6. COMMISSIONING

PRE-COMMISSIONING

Before the system is started, it is recommended that the following checks are made:-

- 6.1. The unit is adequately cooled and all the wiring to the module is of a standard and rating compatible with the system.
- 6.2. The unit **DC** supply is fused and connected direct to the battery and of correct polarity.
- 6.3. The Emergency Stop input is wired to an external normally closed switch connected to **DC** positive.

 **NOTE:- If Emergency Stop feature is not required link this input to the DC Positive.**

- 6.1. To check the start cycle take appropriate measures to prevent the engine from starting (disable the operation of the fuel solenoid). After a visual inspection to ensure it is safe to proceed, connect the battery supply. Turn the selector switch to **“MANUAL”**. The unit start sequence will commence.
- 6.2. The starter will engage and operate for the pre-set crank period. After the starter motor has attempted to start the engine for the pre-set number of attempts **“FAILED TO START” LED** will be illuminated. Turn to **OFF** to reset the unit.
- 6.3. Restore the engine to operational status (reconnect the fuel solenoid), again select **“MANUAL”** and this time the engine should start and the starter motor should disengage automatically. If not then check that the engine is fully operational (fuel available, etc.) and that the fuel solenoid is operating. The engine should now run up to operating speed. If not, and an alarm is present, check the alarm condition for validity, then check input wiring. The engine should continue to run for an indefinite period.
- 6.4. Select **AUTO** on the front panel, the engine will run for the pre-set cooling down period, then shutdown. The generator should stay in the standby mode. If not check that there is not a signal present on the **Remote Start** input.
- 6.5. Initiate a remote start by grounding the **Remote Start** input. The start sequence will start and the engine will run up to operational speed. If one of the Auxiliary Outputs has been configured for Load Transfer, the Generator will accept the load. If not, check the wiring to the Generator Contactor Coil. Check the Warming timer has timed out.
- 6.6. Remove the Remote Start signal, the return sequence will start. After the pre-set time period, the load will be removed from the generator. The generator will then run for the pre-set cooling down period, then shutdown.
- 6.7. All internal timers and selections should now be adjusted to the customers specifications or to the engine and alternator manufacturers recommendations.
- 6.8. If despite repeated checking of the connections between the **521** and the customers system, satisfactory operation cannot be achieved, then the customer is requested to contact the factory for further advise on:-

INTERNATIONAL TEL: 44 (0) 1723 377566
INTERNATIONAL FAX: 44 (0) 1723 354453
E-mail: Support@Deepseapl.com

7. FAULT FINDING

SYMPTOM	POSSIBLE REMEDY
Unit is inoperative	Select AUTO on the front panel. Check the battery and wiring to the unit. Check the DC supply. Check the DC fuse.
Unit shuts down	Check DC supply voltage is not above 35 Volts or below 8 Volts Check the operating temperature is not above 55 °C. Check the DC fuse.
Unit locks out on Emergency Stop	If an Emergency Stop Switch is not fitted, ensure that a positive is connected to the Emergency Stop input. Check emergency stop switch is functioning correctly. Check Wiring is not open circuit.
Intermittent sensor fault	Ensure that Magnetic pick-up screen is only connected at one end, if connected at both ends this enables the screen to act as an aerial and will pick up random voltages.
Low oil Pressure fault operates after engine has fired	Check engine oil pressure. Check oil pressure switch and wiring. Check configured polarity is correct.
High engine temperature fault operates after engine has fired.	Check engine temperature. Check switch and wiring. Check configuration of input i.e. Normally Open or Normally Closed.
Shutdown fault operates	Check relevant switch and wiring of illuminated fault LED. Check configuration of input. If only common alarm LED illuminated, please refer to section 2, note 2.
Warning fault operates	Check relevant switch and wiring of illuminated fault LED. Check configuration of input. If only common alarm LED illuminated, please refer to section 2, note 2.
Fail to Start is activated after pre-set number of multi attempts to start	Check wiring of fuel solenoid. Check fuel. Check battery supply. Check battery supply is present on the Fuel output of the module. Check the speed sensing signal is present on the 521 inputs. Refer to engine manual.
Continuous starting of generator when in AUTO	Check that there is no signal present on the Remote Start input. Check configured polarity is correct.
Generator fails to start on receipt of Remote Start signal	Check Start Delay timer has timed out. Check signal is on Remote Start input.
Pre-heat inoperative	Check wiring to engine heater plugs. Check battery supply. Check battery supply is present on the Pre-heat output of module. Check pre-heat has been selected in the configuration menu.
Starter motor inoperative	Check wiring to starter solenoid. Check battery supply. Check battery supply is present on the Starter output of module. Ensure that the Emergency Stop input is at +Ve.
Engine runs but generator will not take load	Check Warm up timer has timed out. Check configuration to ensure output has been selected to give Load Transfer.

 **NOTE:-** Fault finding can be assisted greatly by utilising the Diagnostic feature available from the PC Interface. This will display the module state, any alarm conditions present and the state of all inputs and outputs. It is recommended that diagnostics are used to aid fault finding where-ever possible.

8. TYPICAL WIRING DIAGRAM

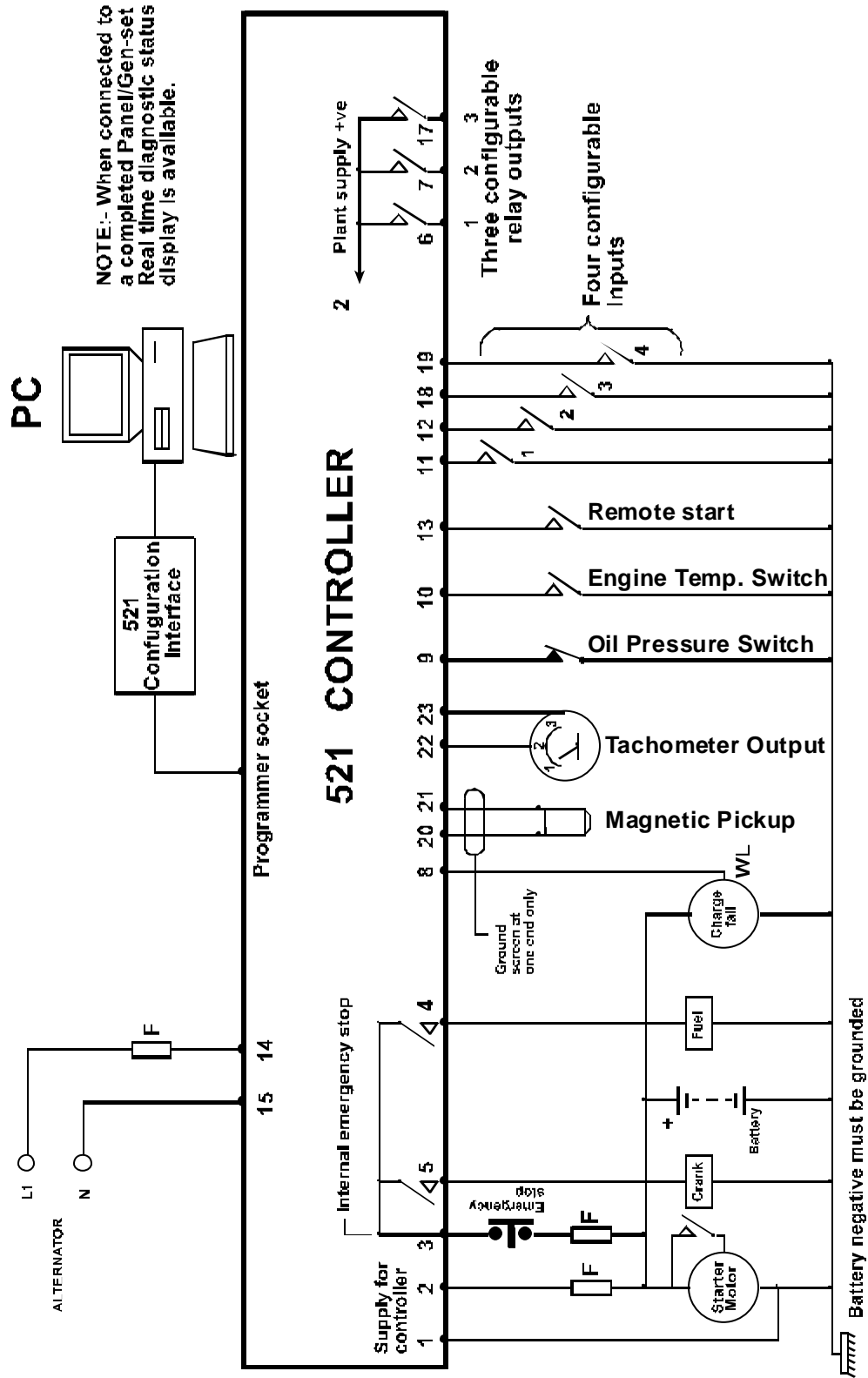

9. CALIBRATION

The 521 module can be calibrated by using either a PC with Interface Module 808 .

9.1 PC INTERFACE MODULE 808











The PC interface 808 kit comprises the following:-

- 808 Interface Module
- 25 to 9 way adapter
- FCC 68 (4 Pin) Connecting Lead
- Floppy disc with configuration software

10. ICON DESCRIPTIONS

The DSE P521 module is available with graphical icons instead of text. This is for use where text in the English language may cause problems and also allows for a standard module for all world markets to be used.

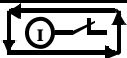
10.1 ICONS

Symbol	Meaning	Description
	Stop/Reset	Stop the generator and reset any alarm conditions. Refer to Section 1 of this Manual.
	Auto	The controller will automatically start the generator when given a remote start command. Refer to section 1.2 of this Manual.
	Manual	The controller will start the generator under manual control. Refer to section 1.3 of this Manual.
	Low Oil Pressure	A low oil pressure shutdown has occurred. Refer to section 2.2 of this Manual.
	High Engine Temperature	A High Engine Temperature shutdown has occurred. Refer to section 2.2 of the Manual.
	Overspeed	An overspeed shutdown has occurred. Refer to section 2.2 of this Manual.
	Fail to start/Over-crank	The engine has failed to start after the pre-set number of attempts. Refer to section 2.2 of this manual
	Charge Fail	The charge alternator on the engine is not giving sufficient output. Refer to section 2.1 of this Manual.
	Common Alarm	An alarm condition has been detected. Refer to section 2 of this Manual. (Warning = Steady, Shutdown = Flashing)
	Remote Start Active	The remote start signal is being applied to the module.
	DC Power On	The module is being supplied with a suitable DC supply.

11. APPENDIX

11.1 LED IDENTIFICATION DIAGRAM



FIG 6

Note:- The Software disk supplied with the Calibration Interface (808) contains a Microsoft Word document for the automatic creation of suitable label inserts for the Auxiliary LED's.

11.2 FACTORY DEFAULT CONFIGURATION

The 521 module when shipped contains the following configuration, allowing it to be used as a standard module if no configuration interface is available.

P52x Configuration

Title: Standard default settings factory set

Created by: Miles Revell

Date: 4 March 1997

Filename: P521A

MISCELLANEOUS ITEMS

Item	Value
Start attempts	3
Alternator frequency input present	Yes
Nominal frequency	50Hz
Alternator poles	4
Magnetic pickup input present	No
Flywheel teeth	118
Nominal RPM	1500
Lamp test enabled	No
Start button	None
Stop button	None
Safety on delay time termination	Premature
Load transfer mode	Normal
Pre-heat mode	Normal
Tachometer full scale current	0.5mA

Tachometer full scale RPM	2500
Electrical trip enabled	No

CONFIGURABLE INPUTS

Input channel	Polarity	Type	Activation time
Remote start	Close to activate		
Low oil pressure	Close to activate	Shutdown	Active from safety on
High engine temp.	Close to activate	Shutdown	Active from safety on
Auxiliary input 1	Close to activate	Warning	Always active
Auxiliary input 2	Close to activate	Warning	Active from safety on
Auxiliary input 3	Close to activate	Shutdown	Active from safety on
Auxiliary input 4	Close to activate	Indication	Always active

RELAY OUTPUTS

Output channel	Polarity	Control source
Auxiliary output 1	Energize	1 Pre-heat
Auxiliary output 2	Energize	18 Common alarm
Auxiliary output 3	Energize	4 Load transfer

FRONT PANEL LED'S

LED	Polarity	Control source
LED 1	Lit	25 Remote start present
LED 2	Lit	21 Charge fail alarm
LED 3	Lit	18 Common alarm
LED 4	Lit	20 Overspeed alarm
LED 5	Lit	7 Fail to start alarm
LED 6	Lit	28 High engine temp. Alarm
LED 7	Lit	27 Low oil pressure alarm
LED 8	Lit	32 Auxiliary IP 4 active
LED 9	Lit	31 Auxiliary IP 3 active
LED 10	Lit	30 Auxiliary IP 2 active
LED 11	Lit	29 Auxiliary IP 1 active

SYSTEM TIMERS

Timer	Mins:secs
Remote start delay time	0:05
Remote stop delay time	0:30
Cranking time	0:10
Crank rest time	0:10
Safety on delay time	0:10
Warm up time	0:05
Cooling time	0:30
Fail to stop time	0:30
ETS hold time	0:00
Pre-heat time	0:00
Sensor fail delay time	0:02
Smoke limiting time	0:00
Smoke limiting ramp time	0:00

ANALOGUE LEVELS

Level	Value
Overspeed on alternator frequency	57.0 Hz
Overspeed on magnetic pickup	1750 RPM
Overspeed overshoot during safety on delay	0 %
Underspeed on alternator frequency	30.0 Hz
Underspeed on magnetic pickup	1250 RPM
Crank disconnect on alternator frequency	21.0 Hz
Crank disconnect on magnetic pickup	600 RPM
Crank disconnect charge alternator voltage	30.0 V
Charge fail voltage	8.0 V

